

**SOLJET PRO III**  
SIGN MAKER BY ROLAND DG CORPORATION

---

---

# ***XC-540***

## **USER'S MANUAL**

---

---

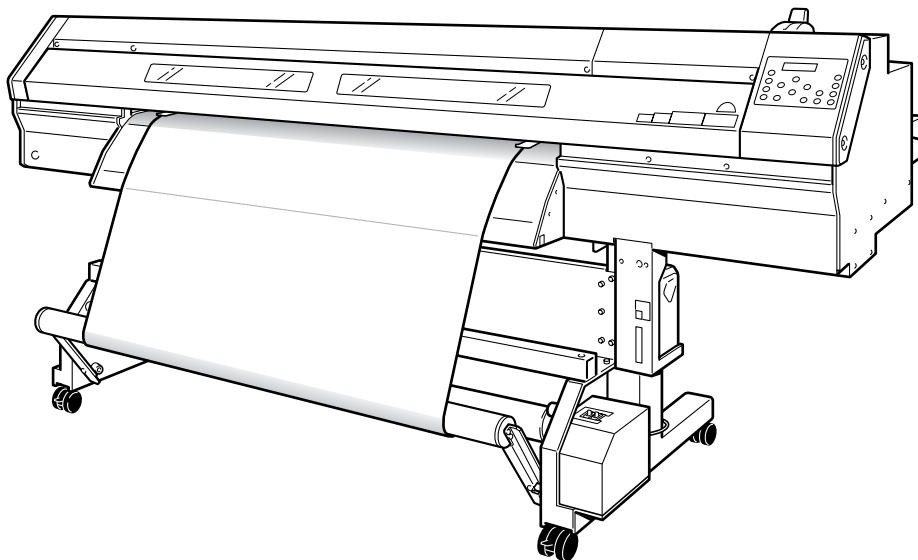

---

Thank you very much for purchasing this product.

- To ensure correct and safe usage with a full understanding of this product's performance, please be sure to read through this manual completely and store it in a safe location.
  - Unauthorized copying or transferral, in whole or in part, of this manual is prohibited.
  - The contents of this operation manual and the specifications of this product are subject to change without notice.
  - The operation manual and the product have been prepared and tested as much as possible. If you find any misprint or error, please inform us.
  - Roland DG Corp. assumes no responsibility for any direct or indirect loss or damage which may occur through use of this product, regardless of any failure to perform on the part of this product.
  - Roland DG Corp. assumes no responsibility for any direct or indirect loss or damage which may occur with respect to any article made using this product.
-

**For the USA**

**FEDERAL COMMUNICATIONS COMMISSION  
RADIO FREQUENCY INTERFERENCE  
STATEMENT**

This equipment has been tested and found to comply with the limits for a Class A digital device, pursuant to Part 15 of the FCC Rules.

These limits are designed to provide reasonable protection against harmful interference when the equipment is operated in a commercial environment.

This equipment generates, uses, and can radiate radio frequency energy and, if not installed and used in accordance with the instruction manual, may cause harmful interference to radio communications.

Operation of this equipment in a residential area is likely to cause harmful interference in which case the user will be required to correct the interference at his own expense.

Unauthorized changes or modification to this system can void the users authority to operate this equipment.

**NOTICE**

**Grounding Instructions**

Do not modify the plug provided - if it will not fit the outlet, have the proper outlet installed by a qualified electrician.

Check with qualified electrician or service personnel if the grounding instructions are not completely understood, or if in doubt as to whether the tool is properly grounded.

Use only 3-wire extension cords that have 3-prong grounding plugs and 3-pole receptacles that accept the tool's plug.

Repair or replace damaged or worn out cord immediately.

**Operating Instructions**

**KEEP WORK AREA CLEAN.** Cluttered areas and benches invites accidents.

**DON'T USE IN DANGEROUS ENVIRONMENT.** Don't use power tools in damp or wet locations, or expose them to rain. Keep work area well lighted.

**DISCONNECT TOOLS** before servicing; when changing accessories, such as blades, bits, cutters, and like.

**REDUCE THE RISK OF UNINTENTIONAL STARTING.** Make sure the switch is in off position before plugging in.

**USE RECOMMENDED ACCESSORIES.** Consult the owner's manual for recommended accessories. The use of improper accessories may cause risk of injury to persons.

**NEVER LEAVE TOOL RUNNING UNATTENDED.**  
**TURN POWER OFF.** Don't leave tool until it comes to a complete stop.

**For Canada**

**CLASS A NOTICE**

This Class A digital apparatus meets all requirements of the Canadian Interference-Causing Equipment Regulations.

**CLASSE A AVIS**

Cet appareil numérique de la classe A respecte toutes les exigences du Règlement sur le matériel brouilleur du Canada.



**ROLAND DG CORPORATION**

1-6-4 Shinmiyakoda, Hamamatsu-shi, Shizuoka-ken, JAPAN 431-2103

**MODEL NAME** : See the MODEL given on the rating plate.

**RELEVANT DIRECTIVE** : EC LOW VOLTAGE DIRECTIVE (73/23/EEC)

**EC ELECTROMAGNETIC COMPATIBILITY DIRECTIVE (89/336/EEC)**

**WARNING**



This is a Class A product. In a domestic environment this product may cause radio interference in which case the user may be required to take adequate measures.



As an ENERGY STAR® Partner, Roland DG Corp. has determined that this product meets the ENERGY STAR® guidelines for energy efficiency.

The International ENERGY STAR® Office Equipment Program is an international program that promotes energy saving through the penetration of energy efficient computers and other office equipment. The program backs the development and dissemination of products with functions that effectively reduce energy consumption. It is an open system in which business proprietors can participate voluntarily. The targeted products are office equipment such as computers, monitors, printers, facsimiles, copiers, scanners, and multifunction devices. Their standards and logos are uniform among participating nations.

# Contents

 <b>To Ensure Safe Use</b> .....	<b>5</b>
 <b>Pour utiliser en toute sécurité</b> .....	<b>12</b>
Important Notes on Handling and Use .....	19
Printer unit .....	19
Ink cartridges .....	20
<b>Chapter 1 Introduction</b> .....	<b>21</b>
1-1 Features of the Machine .....	22
1-2 Part Names and Functions .....	23
Printer Unit/Dryer .....	23
Operation Panel .....	25
Media Take-up System .....	26
<b>Chapter 2 Operation</b> .....	<b>27</b>
2-1 Switching the Power On and Off .....	28
Switching the Power On and Off .....	28
The Power-saving Feature .....	29
2-2 Loading and Cutting Off Media .....	30
How to Load Media .....	30
How to Cut Off Media .....	35
2-3 Settings of the Media Heating System .....	36
What Is the Media Heating System? .....	36
Making the Temperature Setting for the Media Heating System .....	36
General Guide for the Preset Temperatures .....	37
2-4 Starting Output .....	39
Getting Ready to Receive Data from a Computer .....	39
Printing Tests and Cleaning .....	40
2-5 If Ink Runs Out .....	42
Checking for Remaining Ink .....	42
If Ink Runs Out .....	43
<b>Chapter 3 Using the Cutting Feature</b> .....	<b>45</b>
3-1 Performing Cutting .....	46
To Perform Cutting .....	46
Performing a Cutting Test .....	47
Making the Setting for Blade Force .....	47
3-2 Performing Printing Followed Immediately by Cutting .....	48
Performing Printing Followed Immediately by Cutting .....	48
3-3 Cutting Using the Crop-mark Feature .....	49
How to Use the Crop-mark Feature .....	49
Printing with Crop Marks .....	49
Performing Cutting with Automatic Crop-mark Detection .....	51
Aligning Manually and Cutting .....	52
<b>Chapter 4 Operation of the Media Take-up System</b> .....	<b>55</b>
4-1 The Take-up System .....	56
Features of the Take-up System .....	56
Operating Conditions for the Take-up System .....	56
4-2 Using the Take-up System .....	57
How to Take Up Media .....	57
How to Remove Taken-up Media .....	60

<b>Chapter 5 Maintenance and Adjustment .....</b>	<b>61</b>
5-1 Daily Care and Maintenance .....	62
Disposing of Discharged Ink .....	62
Cleaning .....	64
Care and Maintenance of the Print Heads .....	65
5-2 When Head Cleaning Is Not Effective .....	66
Performing More Powerful Cleaning .....	66
When Powerful Cleaning Is Not Effective .....	67
5-3 Cleaning the Heads Using the Cleaning Kit .....	68
When the Cleaning Kit Becomes Necessary .....	68
How to Perform Cleaning .....	68
5-4 Replacing Consumable Parts .....	72
Replacing the Wipers .....	72
Replacing the Blade .....	74
Replacing the Separating Knife .....	76
5-5 When Not in Use for a Prolonged Period .....	78
Keep Performing Maintenance .....	78
Alarm Feature .....	78
Important Note on Draining Ink .....	78
5-6 When Moving the Unit .....	79
Procedures from Preparing to Move Through Reinstalling .....	79
<b>Chapter 6 Feature Reference .....</b>	<b>81</b>
6-1 Pausing or Canceling Output .....	82
Canceling Output Before It Finishes .....	82
6-2 Setting the Location for Starting Output .....	83
Setting the Output-start Location .....	83
6-3 Matching the Printer to the Operating Environment .....	84
Making the Setting for Automatic Adjustment of the Printer to the Operating Environment .....	84
6-4 Accommodating Various Kinds of Media .....	85
Adjusting Head Height to Match Media Thickness .....	85
Using Transparent Media .....	86
Printing Hard-to-dry Media .....	86
Preventing Media from Coming Loose .....	87
Speeding Up Output for Narrow Media .....	88
Keeping Media from Being Soiled by Ink Drops .....	88
How to Load Sheet Media .....	90
6-5 Setting How the Printer Operates .....	91
Determining What Happens When an Ink Cartridge Is Empty .....	91
Changing the Type of Ink .....	91
Setting the Interval until Activation of the Sleep Mode .....	92
Deactivating the Sleep Mode .....	92
Preventing Pulling of the Media with Undue Force When Performing Cutting Only .....	93
Drying the Trailing Edge of the Printing Area on the Dryer .....	93
Giving Priority to Image Quality .....	94
Changing the Menu Language and the Units of Measurement .....	94
Displaying the Amount of Remaining Media on the Printer's Screen .....	95
Verifying the Setting for the Amount Remaining Every Time the Media Is Changed .....	95
Printing the Amount of Remaining Media .....	96
Returning All Settings to Their Initial Values .....	96
6-6 Making Various Adjustments for Cutting .....	97
Performing Distance Correction During Cutting .....	97
Fine-tuning the Cutting Conditions .....	98
Accurately Adjusting the Cutting-in Amount .....	99
Making the Cutting Conditions Set on the Machine Take Precedence .....	99

6-7 Correcting Misalignment for Printing or Cutting .....	100
Correcting for Misalignment in Bidirectional Printing .....	100
Correcting for Misalignment in Bidirectional Printing More Precisely .....	101
Performing Feed Correction to Alleviate Horizontal Bands and the Like .....	103
Correcting Misalignment of the Printing and Cutting Positions	
During Printing Followed Immediately by Cutting .....	104
Correcting Misalignment for Printing and Cutting When Using Crop Marks .....	107
6-8 Setting How the Media Heating System Operates .....	110
Switching Off the Preheater, Print Heater, or Dryer .....	110
Determining How the Media Heating System Operates .....	111
6-9 Setting How the Auxiliary Dryer Operates .....	112
Switching the Drying-heater Unit On and Off .....	112
Switching the Optional Blower-fan Unit On and Off .....	113
6-10 Saving the Printer Settings to Match the Media .....	114
Saving Optimized Media Settings As Preset Values .....	114
Loading a Saved Preset .....	116
Assigning a Name to a Preset .....	116
6-11 Making the Network Settings .....	117
Setting IP address, Subnet mask, etc. ....	117
6-12 Viewing System Information .....	118
Viewing the Serial Number, Firmware Version, and Other Information .....	118
Viewing the Network Settings .....	118
Printing a System Report .....	119
6-13 Performing Maintenance .....	120
Draining Ink and Performing Internal Washing .....	120
Draining Ink Remaining Inside the Machine .....	120
6-14 Menu List .....	121
Main menu .....	121
Language and Unit Menu .....	126
Cleaning Menu .....	126
Heater Configuration Menu .....	126
Cut Configuration Menu .....	127
<b>Chapter 7 What to Do If .....</b>	<b>129</b>
7-1 The Machine Doesn't Run .....	130
The Printer Unit Doesn't Run .....	130
The Media Take-up System Doesn't Run .....	130
The Media Heating System Doesn't Warm Up .....	130
7-2 Attractive Printing/Cutting Is Impossible .....	131
Printed Results Are Coarse or Contain Horizontal Stripes .....	131
Colors Are Unstable or Uneven .....	131
The Media Becomes Soiled When Printed .....	132
Cutting Is Misaligned or Skewed .....	132
7-3 The Media Jams .....	133
The Media Jams .....	133
7-4 The Media Cannot Be Taken Up Smoothly .....	134
The Media Cannot Be Taken Up Smoothly .....	134
7-5 Media Wrinkles or Shrinks, or Feed Is Unstable .....	135
Media Wrinkles or Shrinks .....	135
Media Feed Is Not Straight .....	135
Media Feed Is Not Smooth .....	135
7-6 The Print Heads Stopped Moving .....	136
What to Do First .....	136
If the Heads Still Do Not Move .....	136
7-7 If a Message Appears .....	137
7-8 If an Error Message Appears .....	138



<b>Chapter 8 Appendix .....</b>	<b>141</b>
8-1 Usable Media .....	142
Conditions for Usable Media .....	142
Acceptable Media Width .....	143
8-2 Printing/Cutting Area .....	144
Maximum Area .....	144
Maximum Area When Using Crop Marks .....	144
The Media-cutoff Location During Continuous Printing .....	145
8-3 About the Blade .....	146
8-4 Locations of the Power Rating and Serial Number Labels .....	147
8-5 Specifications .....	148

ENERGY STAR is a U.S. registered mark.  
Company names and product names are trademarks or registered trademarks of their respective holders.







# To Ensure Safe Use

Improper handling or operation of this machine may result in injury or damage to property. Points which must be observed to prevent such injury or damage are described as follows.

## About WARNING and CAUTION Notices

 <b>WARNING</b>	Used for instructions intended to alert the user to the risk of death or severe injury should the unit be used improperly.
 <b>CAUTION</b>	Used for instructions intended to alert the user to the risk of injury or material damage should the unit be used improperly. * Material damage refers to damage or other adverse effects caused with respect to the home and all its furnishings, as well to domestic animals or pets.

## About the Symbols

	The  symbol alerts the user to important instructions or warnings. The specific meaning of the symbol is determined by the design contained within the triangle. The symbol at left means "danger of electrocution."
	The  symbol alerts the user to items that must never be carried out (are forbidden). The specific thing that must not be done is indicated by the design contained within the circle. The symbol at left means the unit must never be disassembled.
	The  symbol alerts the user to things that must be carried out. The specific thing that must be done is indicated by the design contained within the circle. The symbol at left means the power-cord plug must be unplugged from the outlet.

 **Incorrect operation may cause injury**

 **WARNING**

 **Be sure to follow the operation procedures described in this documentation. Never allow anyone unfamiliar with the usage or handling of the machine to touch it.**

Incorrect usage or handling may lead to an accident.

 **Keep children away from the machine.**  
The machine includes areas and components that pose a hazard to children and may result in injury, blindness, choking, or other serious accident.

 **Never operate the machine while tired or after ingesting alcohol or any medication.**  
Operation requires unimpaired judgment. Impaired judgment may result in an accident.

 **Never use the machine for any purpose for which it is not intended, or use the machine in an undue manner that exceeds its capacity.**  
Doing so may result in injury or fire.

 **For accessories (optional and consumable items, power cord, and the like), use only genuine articles compatible with this machine.**  
Incompatible items may lead to an accident.

 **Before attempting cleaning, maintenance, or attachment or detachment of optional items, disconnect the power cord.**  
Attempting such operations while the machine is connected to a power source may result in injury or electrical shock.

 **Never attempt to disassemble, repair, or modify the machine.**  
Doing so may result in fire, electrical shock, or injury. Entrust repairs to a trained service technician.

 **CAUTION**

 **Exercise caution to avoid being pinched or becoming caught.**  
Inadvertent contact with certain areas may cause the hand or fingers to be pinched or become caught. Use care when performing operations.

 **Never attempt operation while wearing a necktie, necklace, or loose clothing. Bind long hair securely.**  
Such items may become caught in the machine, resulting in injury.

 **Conduct operations in a clean, brightly lit location.**  
Working in a location that is dark or cluttered may lead to an accident, such as becoming caught in the machine as the result of an inadvertent stumble.

 **Never climb or lean on the machine.**  
The machine is not made to support a person. Climbing or leaning on the machine may dislodge components and cause a slip or fall, resulting in injury.

 **Caution: cutting tool.**  
This machine has an internal tool. To avoid injury, handle the tool with care.



**⚠ Danger of electrical short, shock, electrocution, or fire**

**⚠ WARNING**

**!** Connect to an electrical outlet that complies with this machine's ratings (for voltage, frequency, and current). Incorrect voltage or insufficient current may cause fire or electrical shock.

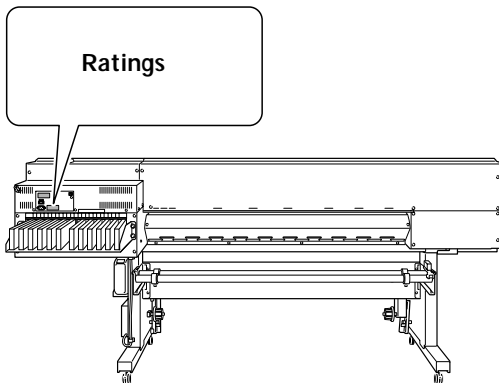

**⊘** Never use out of doors or in any location where exposure to water or high humidity may occur. Never touch with wet hands. Doing so may result in fire or electrical shock.

**⊘** Never allow any foreign object to get inside. Never expose to liquid spills. Inserting objects such as coins or matches or allowing beverages to be spilled into the ventilation ports may result in fire or electrical shock. If anything gets inside, immediately disconnect the power cord and contact your authorized Roland DG Corp. dealer.

**⊘** Never place any flammable object nearby. Never use a combustible aerosol spray nearby. Never use in any location where gases can accumulate. Combustion or explosion may be a danger.

**!** Handle the power cord, plug, and electrical outlet correctly and with care. Never use any article that is damaged. Using a damaged article may result in fire or electrical shock.

**⚠ WARNING**

**!** When using an extension cord or power strip, use one that adequately satisfies the machine's ratings (for voltage, frequency, and current). Use of multiple electrical loads on a single electrical outlet or of a lengthy extension cord may cause fire.

**⏚** Connect to ground. This can prevent fire or electrical shock due to current leakage in the event of malfunction.

**!** Position so that the power plug is within immediate reach at all times. This is to enable quick disconnection of the power plug in the event of an emergency. Install the machine next to an electrical outlet. Also, provide enough empty space to allow immediate access to the electrical outlet.

**!** If sparking, smoke, burning odor, unusual sound, or abnormal operation occurs, immediately unplug the power cord. Never use if any component is damaged. Continuing to use the machine may result in fire, electrical shock, or injury. Contact your authorized Roland DG Corp. dealer.

⚠ Important notes about the power cord, plug, and electrical outlet

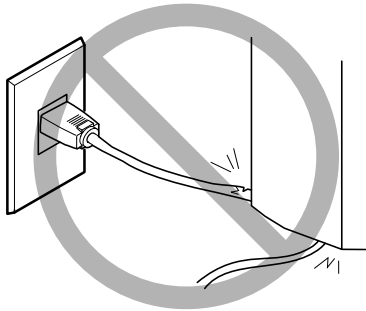

Never place any object on top or subject to damage.

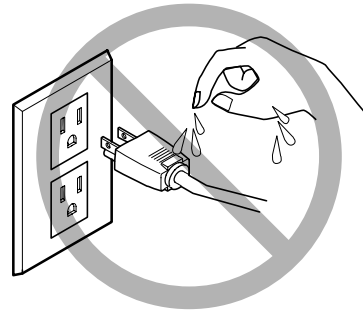

Never allow to get wet.

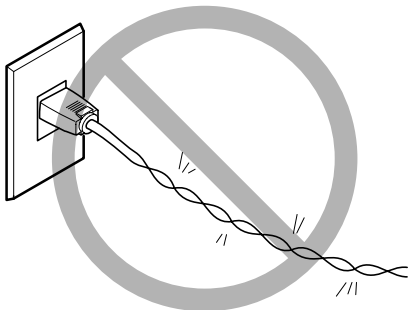

Never bend or twist with undue force.

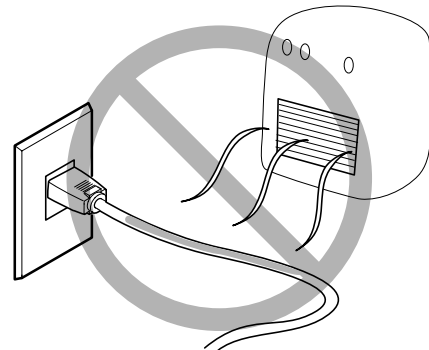

Never make hot.

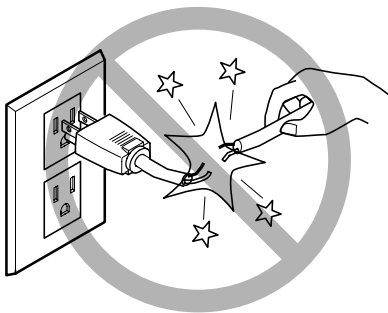

Never pull with undue force.

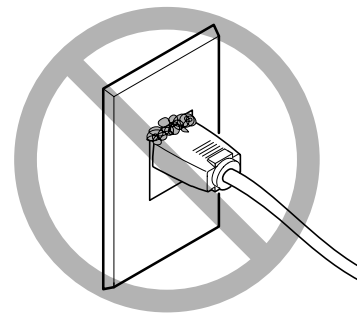

Dust may cause fire.

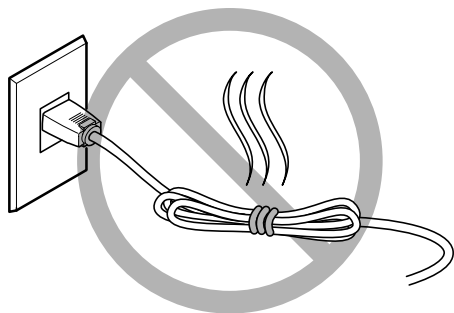

Never bundle, bind, or roll up.

**⚠ Ink, cleaning fluid, and discharged fluid are flammable and toxic**

**⚠ WARNING**

 **Keep open flame away from the work area.**  
Ink and discharged fluid are flammable.

 **Never store ink, cleaning fluid, or discharged fluid in any of the following locations.**

- Any location exposed to open flame
- Any location where high temperature may occur
- Near bleach or any other such oxidizing agent or explosive material
- Any location within the reach of children

Fire may be a danger. Accidental ingestion by children may pose a health hazard.

 **Never place an ink cartridge in fire.**  
Ink may flow out, catch fire, and spread fire to other nearby objects.

 **Never drink or sniff ink, cleaning fluid, or discharged fluid, or allow them to come in contact with the eyes or skin.**  
Doing so may be hazardous to the health.

**⚠ CAUTION**

 **Ensure adequate ventilation for the work area.**  
Failing to perform ventilation may result in a health hazard or danger of combustion due to ink fumes.

 **Never allow an ink cartridge to be subjected to impact, and never attempt to disassemble.**  
Ink may leak.

**⚠ In the event of ingestion or physical distress**

- In the event of contact with the eyes, immediately flush with water for at least 15 minutes. If eye irritation continues, seek treatment by a physician.
- In the event of contact with skin, immediately wash with soap. If irritation or inflammation occur, seek treatment by a physician.
- In the event of ingestion, do not induce vomiting, and immediately seek treatment by a physician. Forcibly inducing vomiting may lead to danger of choking.
- If odor leads to physical distress, move to a well-ventilated location and rest quietly. If dizziness or nausea persists, seek treatment by a physician.

 **This machine weighs 200 kg (441 lb.). Media weighs 30 kg (67 lb.)**

 **WARNING**

 **Install the machine in a location that is level, stable, and able to bear the weight of the machine.**

The total weight of the machine may reach 200 kg (441 lb.) or more. Installation in an unsuitable location may cause a major accident, including tipover, fall, or collapse.

 **Unloading and emplacement are operations that must be performed by 6 persons or more.**

Tasks that require undue effort when performed by a small number of persons may result in physical injury. Also, if dropped, such items may cause injury.

 **WARNING**

 **Be sure to lock the stand's casters.**  
If the machine should begin to topple, a major accident may result, including crushing of the appendages or the body.

 **When storing roll media, implement adequate safety measures to ensure that the stored media will not roll, fall, or topple over.**

Danger exists of becoming pinned under the media and suffering serious injury.

 **Handling roll media is an operation that must be performed by two persons or more, and care must be taken to prevent falls.**

Attempting to lift heavy media in a manner that taxes your strength may cause physical injury.

 **Danger of fire, burns, or toxic gas emissions**

 **WARNING**

 **Caution: high temperatures.**  
Areas such as the dryer become hot. Exercise caution to avoid fire or burns.

 **When printing is not being performed, remove any loaded media or switch off the power.**

The continued application of heat at a single location may cause the release of toxic gases from the media or pose a fire hazard.

 **WARNING**



 **Never use media that cannot withstand heat.**

Doing so may degrade the media, or may result in fire or the release of toxic gases.

## ⚠ Warning Labels

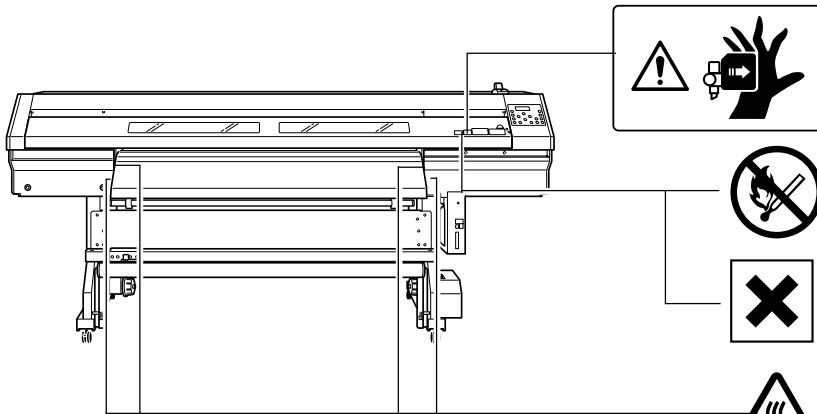
Warning labels are affixed to make areas of danger immediately clear. The meanings of these labels are as follows. Be sure to heed their warnings. Also, never remove the labels or allow them to become obscured.



- 



**Caution: Moving Print Heads**  
The print heads inside the cover move at high speed and pose a hazard. Never insert the hand or fingers into the gap.
- 

**Flammable**  
Ink and discharged fluid are flammable. Keep away from open flame.
- 

**Ink Is Toxic**  
Ink and discharged fluid are toxic. Avoid contact with the body. Use only in a well-ventilated area.
- 

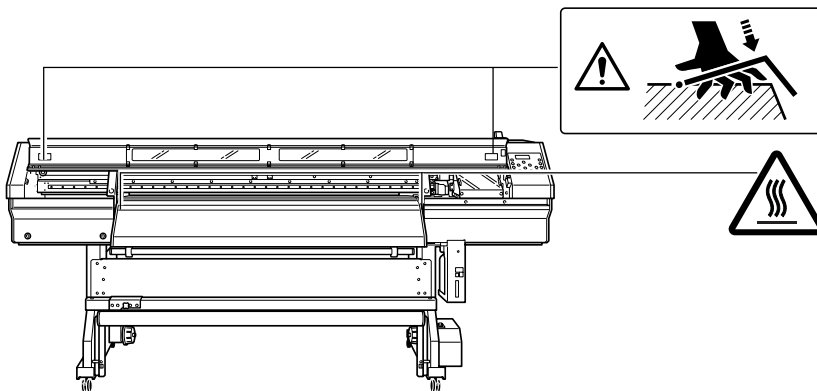
**Caution: High Temperature**  
The platen and dryer become hot. Exercise caution to avoid fire or burns.





- 

**Caution: Pinching Hazard**  
Be careful not to allow the fingers to become pinched when loading media or closing covers.
- 

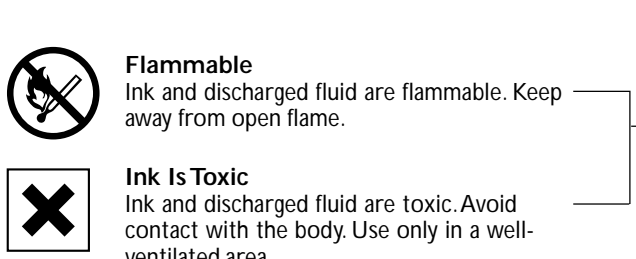
**Caution: High Temperature**  
The platen and dryer become hot. Exercise caution to avoid fire or burns.



- 

**Flammable**  
Ink and discharged fluid are flammable. Keep away from open flame.
- 

**Ink Is Toxic**  
Ink and discharged fluid are toxic. Avoid contact with the body. Use only in a well-ventilated area.

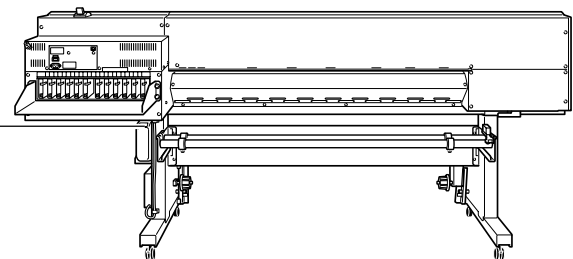







# Pour utiliser en toute sécurité

La manipulation ou l'utilisation inadéquates de cet appareil peuvent causer des blessures ou des dommages matériels. Les précautions à prendre pour prévenir les blessures ou les dommages sont décrites ci-dessous.

## Avis sur les avertissements

 <b>ATTENTION</b>	Utilisé pour avertir l'utilisateur d'un risque de décès ou de blessure grave en cas de mauvaise utilisation de l'appareil.
 <b>PRUDENCE</b>	Utilisé pour avertir l'utilisateur d'un risque de blessure ou de dommage matériel en cas de mauvaise utilisation de l'appareil.  * Par dommage matériel, il est entendu dommage ou tout autre effet indésirable sur la maison, tous les meubles et même les animaux domestiques.

## À propos des symboles

	Le symbole $\triangle$ attire l'attention de l'utilisateur sur les instructions importantes ou les avertissements. Le sens précis du symbole est déterminé par le dessin à l'intérieur du triangle. Le symbole à gauche signifie "danger d'électrocution".
	Le symbole $\otimes$ avertit l'utilisateur de ce qu'il ne doit pas faire, ce qui est interdit. La chose spécifique à ne pas faire est indiquée par le dessin à l'intérieur du cercle. Le symbole à gauche signifie que l'appareil ne doit jamais être démonté.
	Le symbole $\bullet$ prévient l'utilisateur sur ce qu'il doit faire. La chose spécifique à faire est indiquée par le dessin à l'intérieur du cercle. Le symbole à gauche signifie que le fil électrique doit être débranché de la prise.

## ⚠ L'utilisation incorrecte peut causer des blessures

### ⚠ ATTENTION



**S'assurer de suivre les procédures d'utilisation décrites dans la documentation. Ne jamais permettre à quiconque ne connaît pas le fonctionnement ou la manutention de l'appareil de le toucher.** L'utilisation ou la manutention incorrectes peuvent causer un accident.



**Garder les enfants loin de l'appareil.** L'appareil comporte des zones et des composants qui présentent un danger pour les enfants et qui pourraient causer des blessures, la cécité, la suffocation ou d'autres accidents graves.



**Ne jamais faire fonctionner l'appareil après avoir consommé de l'alcool ou des médicaments, ou dans un état de fatigue.** L'utilisation de l'appareil exige un jugement sans faille. L'utilisation avec les facultés affaiblies pourrait entraîner un accident.



**Ne jamais utiliser l'appareil à des fins autres que celles pour lesquelles il est conçu. Ne jamais l'utiliser de manière abusive ou d'une manière qui dépasse sa capacité.** Le non-respect de cette consigne peut causer des blessures ou un incendie.



**Utiliser uniquement des accessoires d'origine (accessoires en option, articles consommables, câble d'alimentation et autres articles semblables), compatibles avec l'appareil.** Les articles incompatibles risquent de causer des accidents.



**Débrancher le câble d'alimentation avant de procéder au nettoyage ou à l'entretien de l'appareil, et avant d'y fixer ou d'en retirer des accessoires en option.** Tenter ces opérations pendant que l'appareil est branché à une source d'alimentation peut causer des blessures ou un choc électrique.



**Ne jamais tenter de démonter, de réparer ou de modifier l'appareil.** Le non-respect de cette consigne risque de provoquer un incendie, un choc électrique ou des blessures. Confier les réparations à un technicien ayant la formation requise.

### ⚠ PRUDENCE



**Faire preuve de prudence pour éviter l'écrasement ou le coincement.** La main ou les doigts peuvent être écrasés ou coincés s'ils entrent en contact avec certaines surfaces par inadvertance. Faire preuve de prudence pendant l'utilisation de l'appareil.



**Ne jamais faire fonctionner l'appareil si on porte une cravate, un collier ou des vêtements amples. Bien attacher les cheveux longs.** Ces vêtements ou ces objets peuvent être coincés dans l'appareil, ce qui causerait des blessures.



**Utiliser l'appareil dans un endroit propre et bien éclairé.** Travailler dans un endroit sombre ou encombré peut causer un accident; l'utilisateur risque, par exemple, de trébucher malencontreusement et d'être coincé par une partie de l'appareil.



**Ne jamais grimper ni s'appuyer sur la machine.** La machine n'est pas conçue pour supporter le poids d'une personne. Grimper ou s'appuyer sur la machine peut déplacer des éléments et causer un faux pas ou une chute, ce qui causerait des blessures.



**Attention : outil de coupe.** Cet appareil contient un outil interne. Pour éviter les blessures, manipuler l'outil avec soin.

**⚠ Risque de décharge ou de choc électrique, d'électrocution ou d'incendie**

**⚠ ATTENTION**



**Brancher à une prise électrique conforme aux caractéristiques de cet appareil (tension, fréquence et courant).**

Une tension incorrecte ou un courant insuffisant peuvent causer un incendie ou un choc électrique.

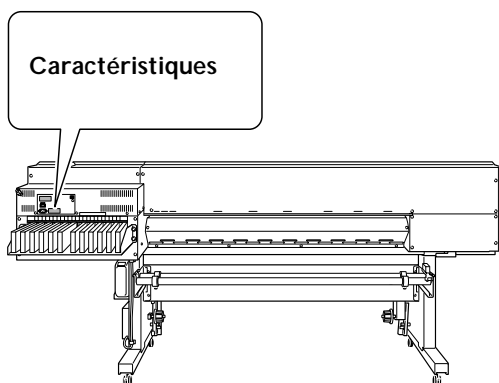

**Ne jamais utiliser à l'extérieur ni à un endroit où l'appareil risque d'être exposé à de l'eau ou à une humidité élevée. Ne jamais toucher l'appareil avec des mains mouillées.**

Le non-respect de cette consigne risque de provoquer un incendie ou un choc électrique.



**Ne jamais insérer d'objet étranger dans l'appareil. Ne jamais exposer l'appareil aux déversements de liquides.**

L'insertion d'objets comme des pièces de monnaie ou des allumettes, ou le déversement de liquides dans les orifices de ventilation peuvent causer un incendie ou un choc électrique. Si un objet ou du liquide s'infiltré dans l'appareil, débrancher immédiatement le câble d'alimentation et communiquer avec le représentant Roland DG Corp. autorisé.



**Ne jamais placer d'objet inflammable à proximité de l'appareil. Ne jamais utiliser de produit inflammable en aérosol à proximité de l'appareil. Ne jamais utiliser l'appareil dans un endroit où des gaz peuvent s'accumuler.**

Une combustion ou une explosion pourraient se produire.

**⚠ ATTENTION**



**Manipuler le câble d'alimentation, la fiche et la prise électrique correctement et avec soin.**

Ne jamais utiliser un article endommagé, car cela pourrait causer un incendie ou un choc électrique.



**Si une rallonge ou une bande d'alimentation électrique sont utilisées, s'assurer qu'elles correspondent aux caractéristiques de l'appareil (tension, fréquence et courant).**

L'utilisation de plusieurs charges électriques sur une prise unique ou une longue rallonge peut causer un incendie.



**Mise à la terre.**

La mise à la terre peut prévenir un incendie ou un choc électrique dus à une fuite de courant en cas de défaillance.



**Placer l'appareil de façon à ce que la fiche soit facile d'accès en tout temps.**

Ainsi, l'appareil pourra être débranché rapidement en cas d'urgence. Installer l'appareil près d'une prise électrique. En outre, prévoir suffisamment d'espace pour que la prise électrique soit facile d'accès.



**S'il se produit des étincelles, de la fumée, une odeur de brûlé, un bruit inhabituel ou un fonctionnement anormal, débrancher immédiatement le câble d'alimentation. Ne jamais utiliser si un composant est endommagé.**

Continuer à utiliser l'appareil peut causer un incendie, un choc électrique ou des blessures. Communiquer avec le représentant Roland DG Corp. Autorisé.



**⚠ Remarques importantes à propos du câble d'alimentation, de la fiche et de la prise électrique**

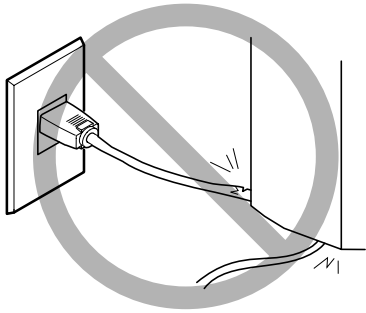

Ne jamais déposer aucun objet sur le câble, sur la fiche ou sur la prise car cela risque de les endommager.

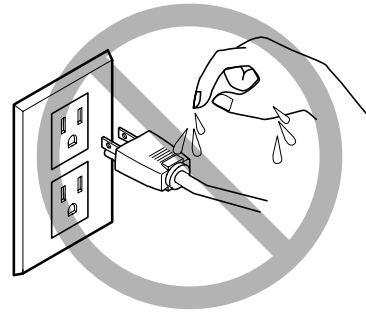

Ne jamais laisser l'eau toucher le câble, la fiche ou la prise.

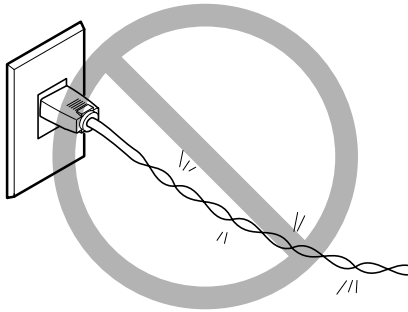

Ne jamais plier ni tordre le câble avec une force excessive.

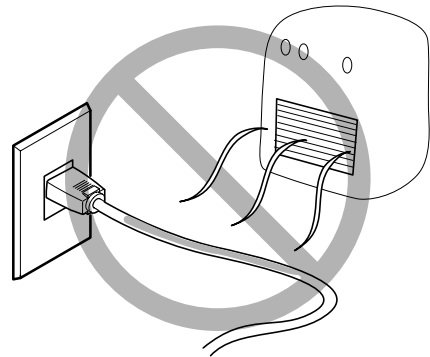

Ne jamais chauffer le câble, la fiche ou la prise.

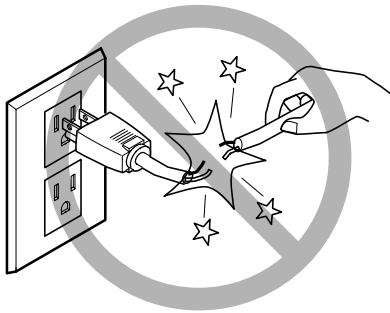

Ne jamais tirer sur le câble ou la fiche avec une force excessive.

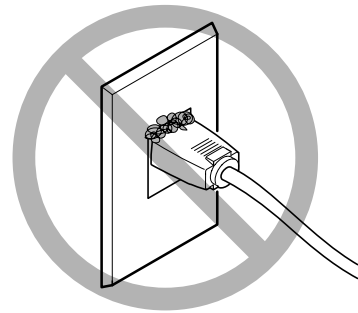

La poussière peut causer un incendie.

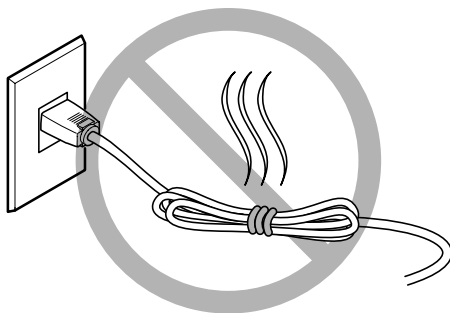

Ne jamais plier ni enrouler le câble.

 **L'encre, les liquides nettoyants et les liquides usés sont inflammables et toxiques**

 **ATTENTION**

 **Ne pas approcher une flamme nue de l'espace de travail.**  
L'encre et les liquides usés sont inflammables.

 **Ne jamais entreposer d'encre, de liquide de nettoyage ou des liquides usés dans les endroits suivants :**

- un endroit exposé à une flamme nue;
- un endroit où il y a risque de température élevée;
- près d'eau de Javel, d'un autre agent d'oxydation ou de matériel explosif;
- tout endroit à la portée d'enfants.

Il y a risque d'incendie. L'ingestion accidentelle par un enfant peut présenter un risque pour la santé.

 **Ne jamais incinérer une cartouche d'encre.**  
De l'encre pourrait couler, s'enflammer et le feu se répandre à des objets proches.

 **Ne jamais boire l'encre, le liquide de nettoyage ni les liquides usés, ne pas en respirer les vapeurs et ne pas laisser les produits entrer en contact avec les yeux ou la peau.**  
Cela est dangereux pour la santé.

 **PRUDENCE**

 **S'assurer que le lieu de travail est bien aéré.**  
L'absence d'aération adéquate peut créer une situation dangereuse pour la santé ou un risque de combustion à cause des vapeurs qui émanent de l'encre.

 **Ne jamais soumettre une cartouche d'encre à des chocs. Ne jamais tenter d'ouvrir une cartouche d'encre.**  
De l'encre pourrait s'échapper.

---

 **En cas d'ingestion ou de trouble physique**

- En cas de contact avec les yeux : rincer immédiatement et abondamment à l'eau courante pendant au moins 15 minutes. Si les yeux sont toujours irrités, consulter un médecin.
- En cas de contact avec la peau : laver immédiatement à l'eau et au savon. En cas d'irritation ou d'inflammation de la peau : consulter un médecin.
- En cas d'ingestion : ne pas provoquer le vomissement et demander immédiatement l'aide d'un médecin. Provoquer le vomissement peut créer un risque de suffocation.
- Si l'odeur cause un trouble physique, amener la personne dans un endroit bien aéré et la faire se reposer. Si l'étourdissement ou la nausée persistent, consulter un médecin.

⚠ **Le poids de cet appareil est de 200 kg (441 lb.)  
Le poids du support est de 30 kg (67 lb.)**

### ⚠ ATTENTION



**Installer l'appareil à un endroit stable et plat et capable de supporter son poids.**

Le poids total de l'appareil peut être d'au moins 200 kg (441 lb.). Installer l'appareil à un endroit inapproprié peut provoquer un accident grave comme le renversement, la chute ou l'écrasement.



**Le déchargement et la mise en place doivent être faits par au moins six personnes.**

Les tâches qui exigent un effort trop grand si elles sont exécutées par un petit nombre de personnes peuvent être cause de blessures. La chute d'articles très lourds peut aussi causer des blessures.

### ⚠ ATTENTION



**S'assurer de verrouiller les roulettes de la base.**

Si l'appareil devait commencer à basculer, il s'ensuivrait un accident grave, par exemple l'écrasement de membres ou du corps.



**Prendre les mesures de sécurité adéquates pour l'entreposage des rouleaux de support pour s'assurer qu'ils ne rouleront pas, ne tomberont pas et ne se renverseront pas.**

Il y a risque d'être écrasé par le support et de subir des blessures graves.



**La manutention du support en rouleau doit être faite par deux personnes ou plus et il faut prendre des précautions pour éviter les chutes.**

Tenter de soulever des objets trop lourds peut causer des blessures.

⚠ **Risque d'incendie, de brûlures ou d'émissions de gaz toxiques**

### ⚠ ATTENTION



**Attention : températures élevées.**

Les zones comme le séchoir chauffent. Faire preuve de prudence pour éviter un incendie ou des brûlures.



**Quand aucun travail d'impression n'est en cours, retirer tout support de l'appareil ou couper l'alimentation électrique.**

L'application continue de chaleur à un point unique peut causer l'émission de gaz toxiques ou créer un risque d'incendie.

### ⚠ ATTENTION



**Ne jamais utiliser un support qui ne peut pas supporter la chaleur.**

L'utilisation d'un support qui ne supporte pas la chaleur peut détériorer le support, créer un risque d'incendie ou causer l'émission de gaz toxiques.

## ⚠ Vignettes d'avertissement

Des vignettes d'avertissement sont apposées pour qu'il soit facile de repérer les zones dangereuses. La signification des vignettes est donnée ci-dessous. Respecter les avertissements. Ne jamais retirer les vignettes et ne pas les laisser s'encrasser.

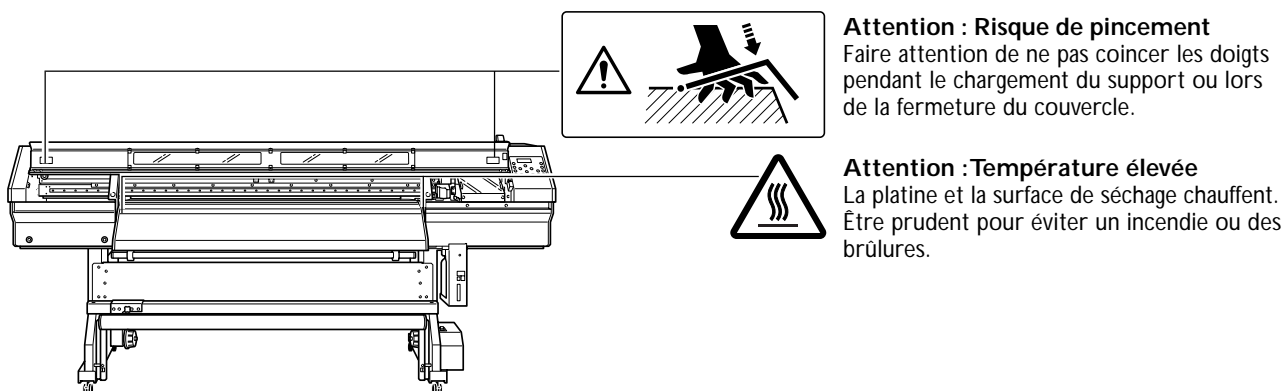
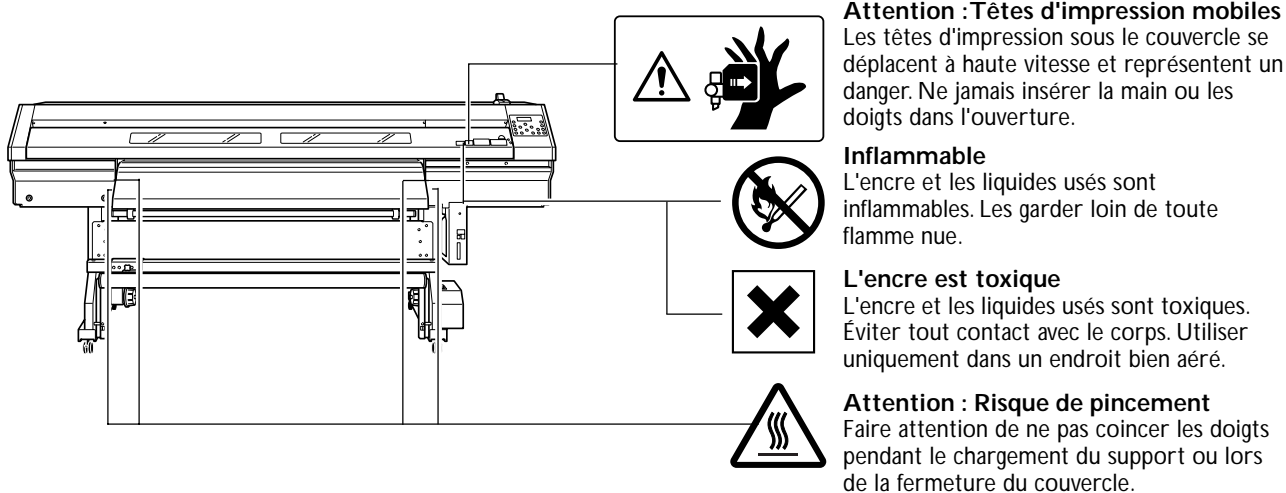

**Inflammable**

L'encre et les liquides usés sont inflammables. Les garder loin de toute flamme nue.



**L'encre est toxique**

L'encre et les liquides usés sont toxiques. Éviter tout contact avec le corps. Utiliser uniquement dans un endroit bien aéré.

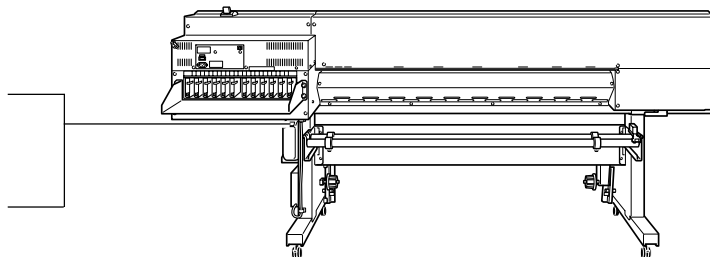

# Important Notes on Handling and Use

This machine is a precision device. To ensure the full performance of this machine, be sure to observe the following important points. Failure to observe them may not only result in loss of performance, but may also cause malfunction or breakdown.

## Printer unit

### *This Machine Is a Precision Device*

---

- Handle carefully, and never subject the machine to impact or excessive force.
- Never needlessly put your hand or fingers inside the cover, the ink-cartridge ports, or other internal areas of the machine.

### *Install in a Suitable Location*

---

- Install in a location having the specified temperature and relative humidity.
- Install in a quiet, stable location offering good operating conditions.

### *The Print Heads Are Delicate*

---

- Never needlessly touch or allow media to scrape them. Failure to handle with care may cause damage.
- The print heads may be damaged if allowed to dry out. The machine prevents desiccation automatically, but improper operation may render this feature inoperative. Operate properly, as specified in this manual.
- Never allow the machine to stand with an ink cartridge removed. Remaining ink in the printer may harden and clog the print heads.
- The print heads are components that wear out. Periodic replacement is required, with the frequency of replacement depending on use.

### *This Machine Becomes Hot*

---

- Never cover the ventilation holes with cloth, tape, or anything else.

## **Ink cartridges**

### *Ink Cartridges Come in Various Types*

---

---

- Use a type that is compatible with the printer. Also, be sure to use only genuine items from Roland DG Corp.

### *Never Subject to Impact or Attempt to Disassemble*

---

---

- Never drop or shake forcefully. The impact may rupture the internal pouch and cause the ink to leak.
- Never attempt to disassemble.
- Never attempt to refill the ink.
- If ink gets on your hands or clothing, wash it off as soon as possible. Removal may become difficult if allowed to stand.

### *Storage*

---

---

- Store unopened in a well-ventilated location at a temperature of 20 to 40°C (68 to 104°F).

# ***Chapter 1***

## ***Introduction***

---

# 1-1 Features of the Machine

---

## **What Is the XC-540?**

The XC-540 is a large-format printer equipped with a cutting feature and combining high speed with high print quality. Not only can it be used either solely for printing or solely for cutting, but it can also perform printing and cutting consecutively. Also, using the crop-mark feature enables you to cut media that has expanded or contracted due to dryer heat, and lets you remove media after printing, then load it again and perform cutting, positioning it accurately. Higher weatherability is achieved through the use of ECO-SOL MAX inks.

## **Built-in Print Server**

This machine has a built-in print server as a network interface. When you use the print server, you can send output data to the machine from anywhere on the network.

## **Built-in Drying Systems**

This machine has a built-in print heater and preheater to improve ink adhesion and speed up drying. It also has a drying heater to speed up drying of the media after printing. This enhances productivity by enabling support for more types of media.

## **Includes a Media Take-up System**

To accommodate printing of lengthy media, the machine includes a media take-up system. This is capable of taking up media automatically during printing. This makes possible unattended operation at night and efficient output of lengthy media.

## **Includes a Software Raster Image Processor (RIP)**

The software RIP included with the machine lets you use your computer to perform raster image processing for output data such as PostScript files exported from a program, and output the data to the machine.



# 1-2 Part Names and Functions

## Printer Unit/Dryer

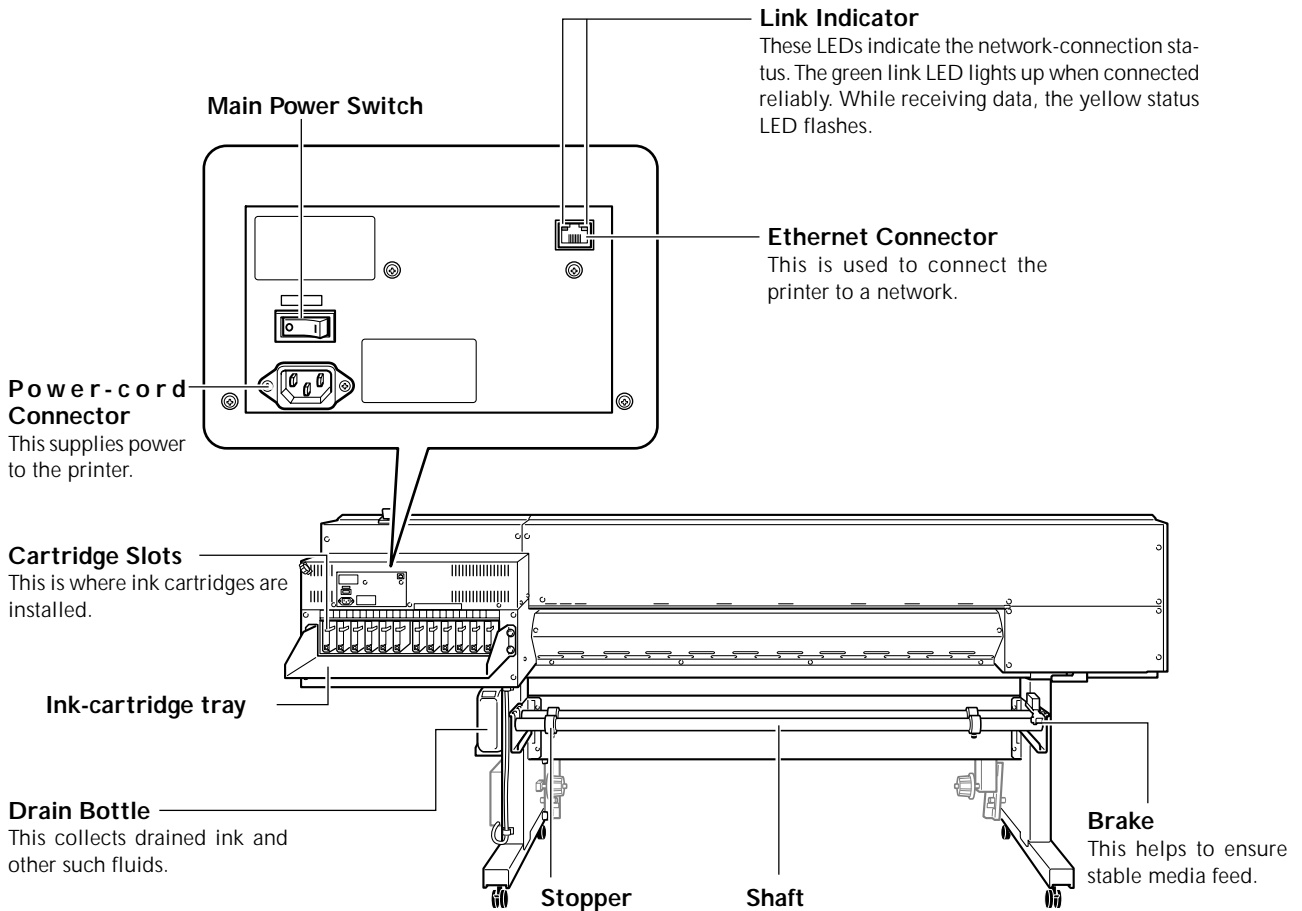
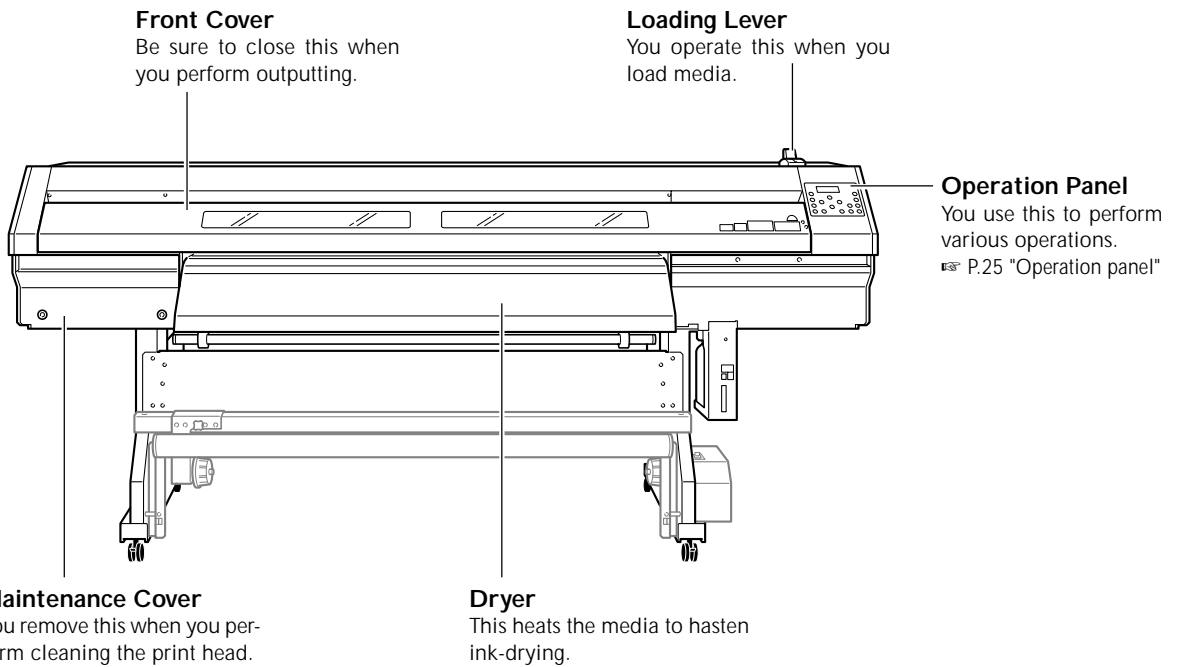

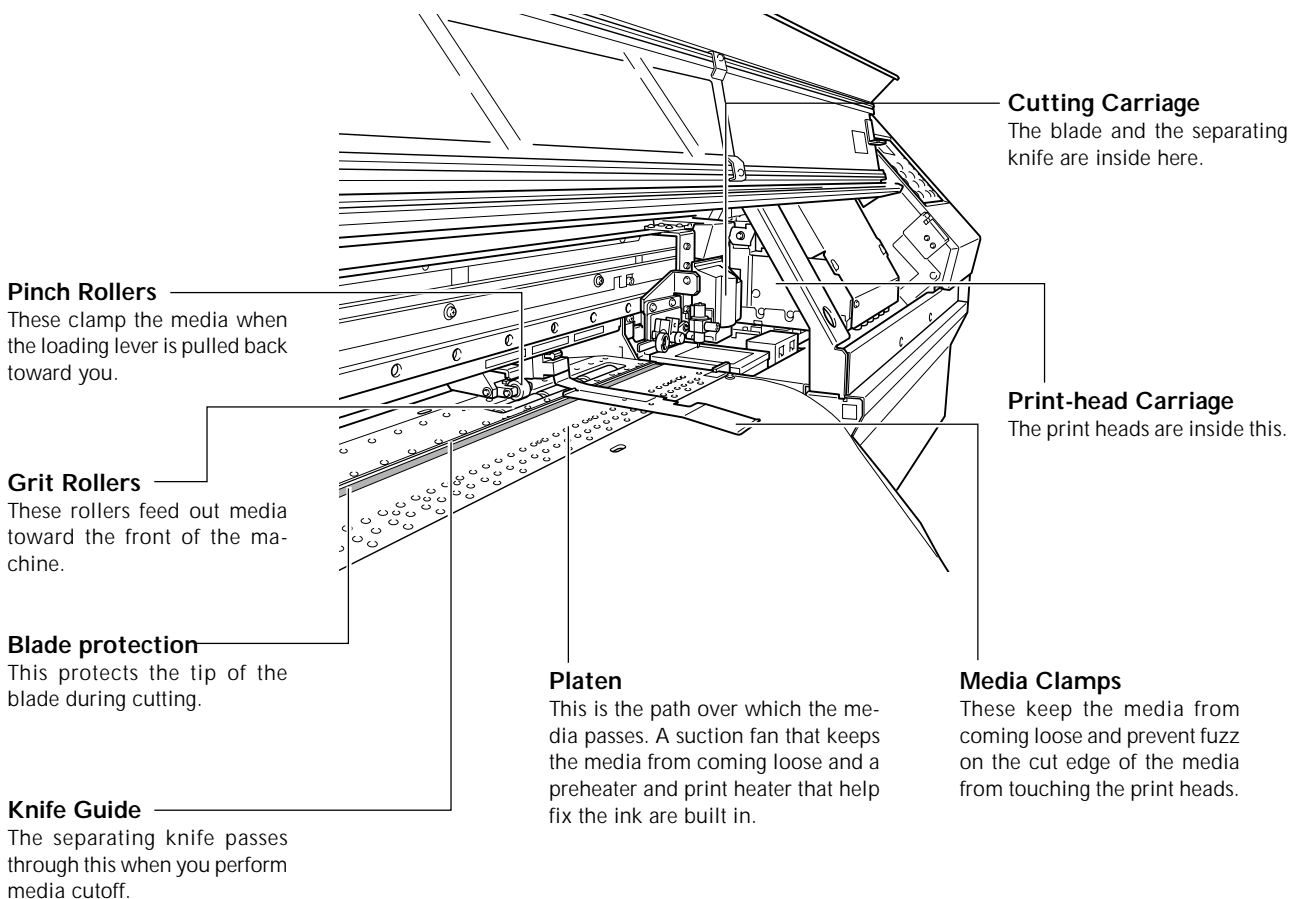



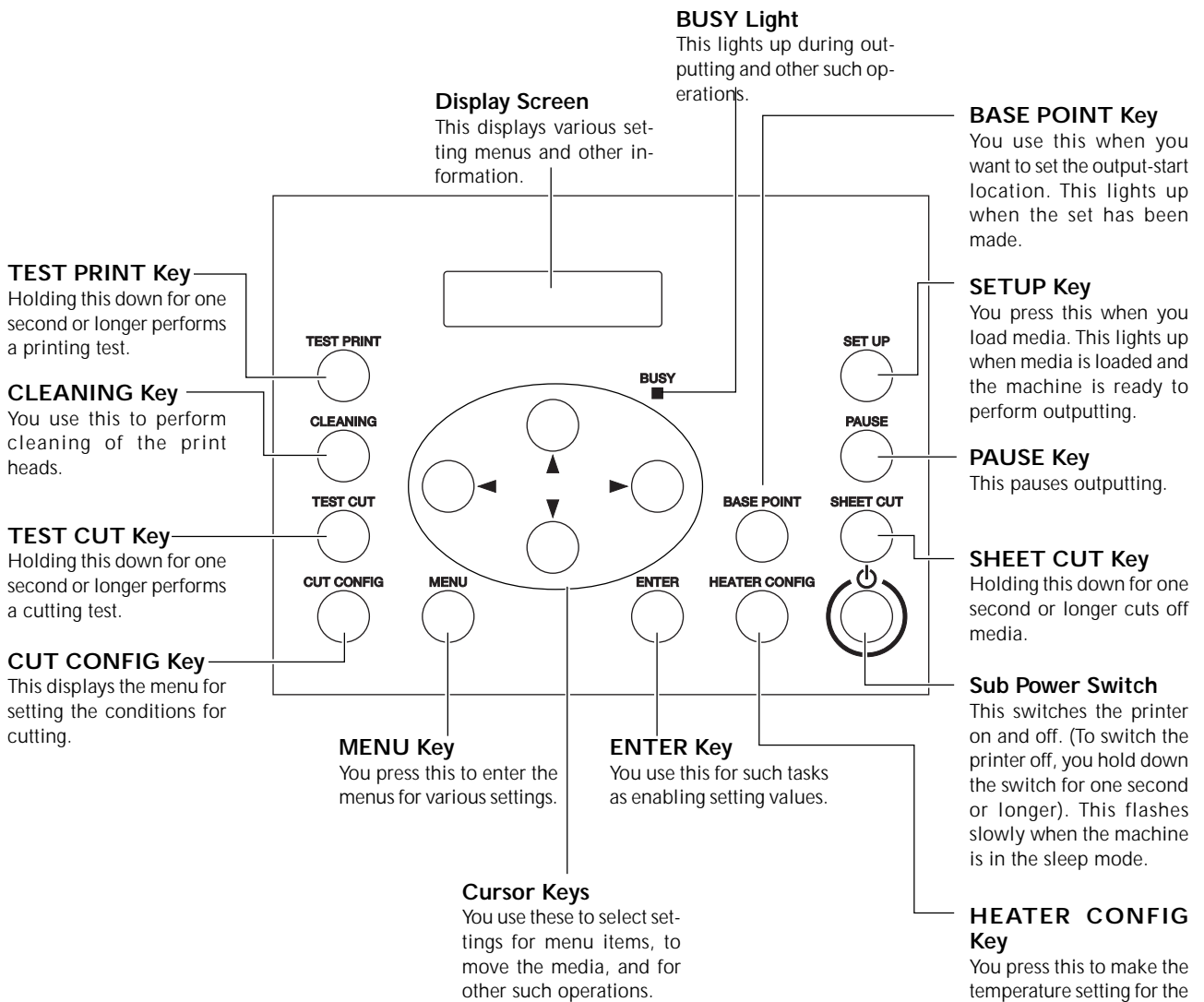





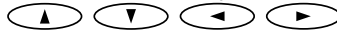

# Operation Panel



## Panel Notation

In this document, the keys and lights on the control panel are indicated by the following images.

-  MENU Key
-  SETUP Key
-  ENTER Key
-  Cursor Keys
-  PAUSE Key
-  CLEANING Key
-  TEST PRINT Key
-  TEST CUT Key
-  BASE POINT Key
-  CUT CONFIG Key
-  HEATER CONFIG Key
-  SHEET CUT Key

## Media Take-up System

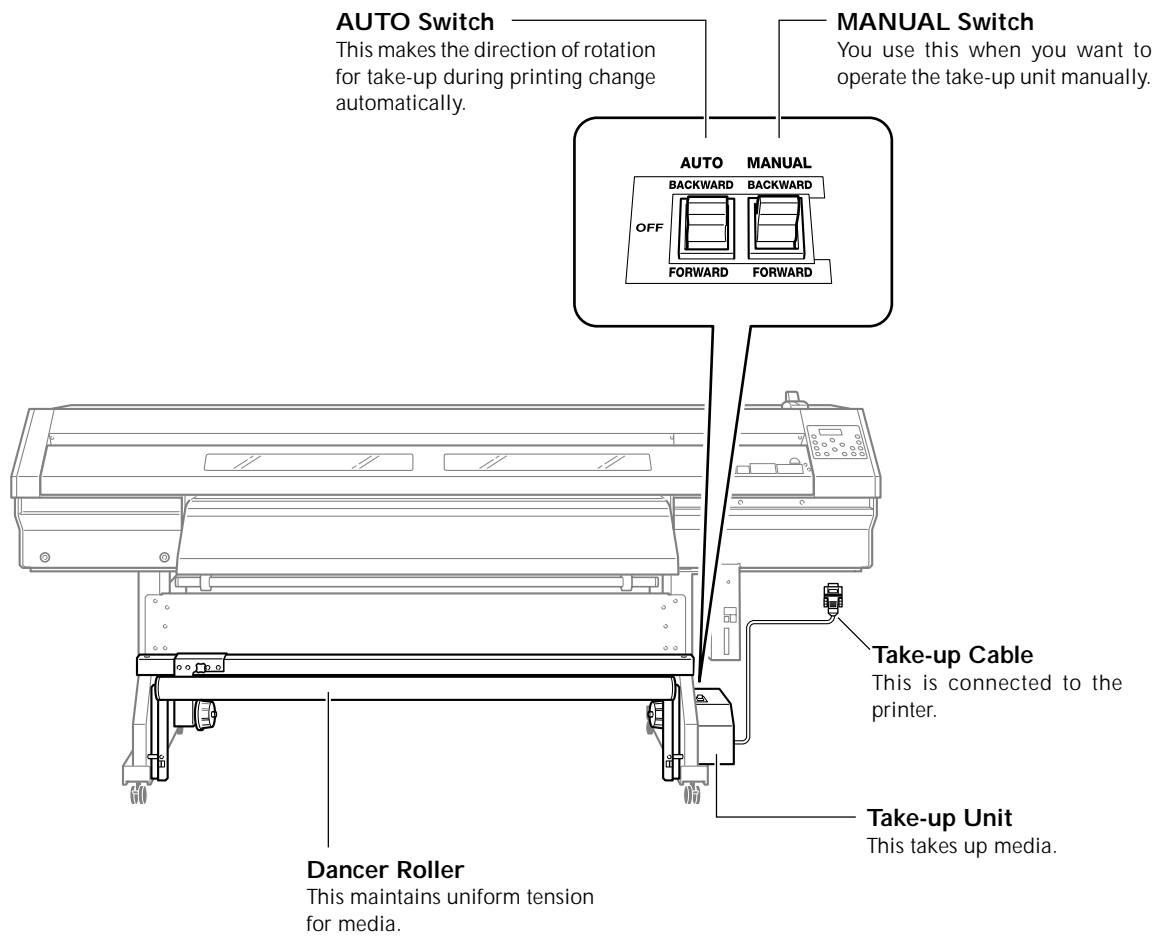

# *Chapter 2*

# *Operation*

---

# 2-1 Switching the Power On and Off

## Switching the Power On and Off

This machine has a main power switch and a sub power switch. Switch on both to use the machine. Whenever outputting is finished, switch off the sub power. Also, raise the loading lever. Leave the main power switches ① on at all times, never switching either one off. An alarm is activated if left on. ☞ P.78 "Alarm Feature"

**⚠ WARNING** When outputting is not being performed, remove any loaded media or switch off the power. The continued application of heat at a single location may cause the release of toxic gases from the media or pose a fire hazard.

### ① Main power switch

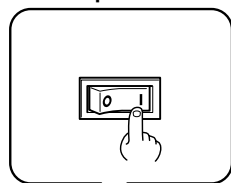

Be sure to leave switched on at all times.

Rear of the printer

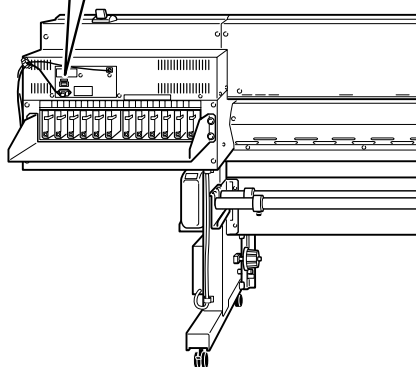

### ② Sub power switch

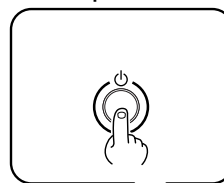

Turn this switch on after closing the front cover. To turn it off, hold down the switch for one second or longer.

Front of the printer

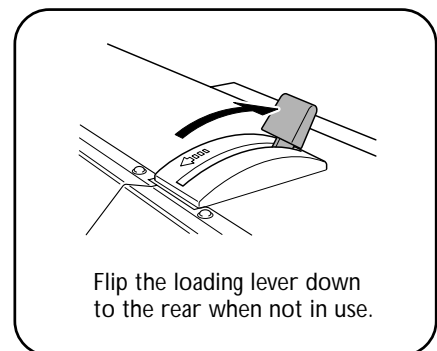
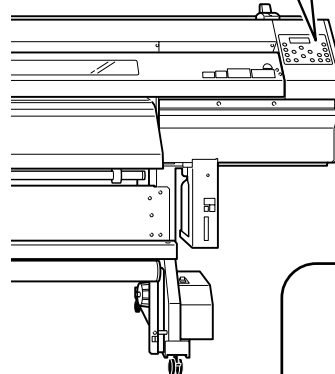

### Important Note on Switching Off the Power

Never switch off the main power or unplug the power cord suddenly while operation is in progress. Doing so may damage the print heads. Be sure to first switch off the sub power.

If the main power is accidentally switched off, immediately turn the power back on.

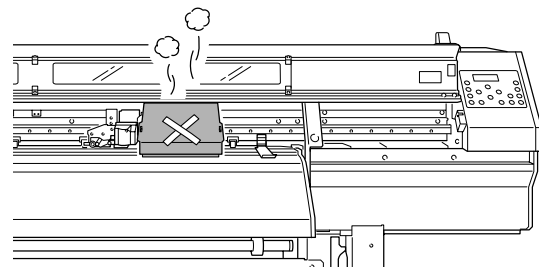

## The Power-saving Feature

This machine is provided with a power-saving feature that switches to a low-power "sleep mode" when a fixed interval passes with no operation. The factory default for the time after which the machine switches to the sleep mode is 30 minutes.

You can change the setting for the time of the shift to the sleep mode. You can also switch off the power-saving feature.

☞ P.92 "Setting the Interval until Activation of the Sleep Mode", P.92 "Deactivating the Sleep Mode"

When the machine is in the sleep mode, the POWER light flashes slowly. Using the control panel or performing operations such as sending output data from the computer (when media is loaded) restore the machine to its normal mode.

To reduce power consumption and prevent problems such as overheating, we recommend leaving the power-saving feature on and setting the activation time for the sleep mode to 30 minutes or less.

# 2-2 Loading and Cutting Off Media

## How to Load Media

- ⚠ CAUTION** Load roll media correctly. Otherwise the media may fall and cause injury.
- ⚠ CAUTION** Roll media weighs about 30 kg (67 lb.). To avoid injury, handle with care.
- ⚠ CAUTION** Never load media that weights more than 30 kg (67 lb.). The machine may fail to withstand the weight and tip over or cause the media to fall.

### 1. Load the media onto the roll shaft.

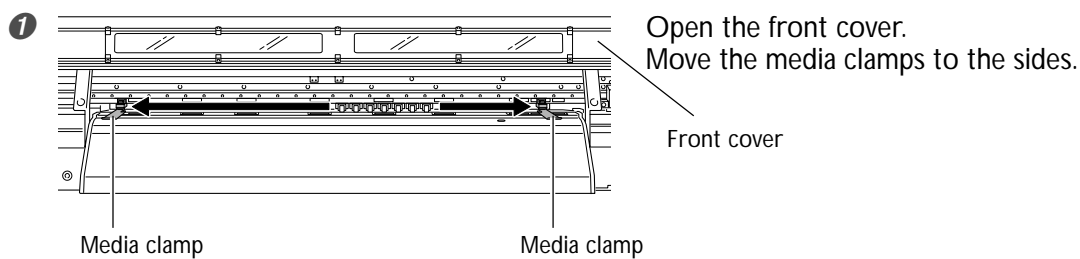

### 2 Attach the media flanges to the roll media.

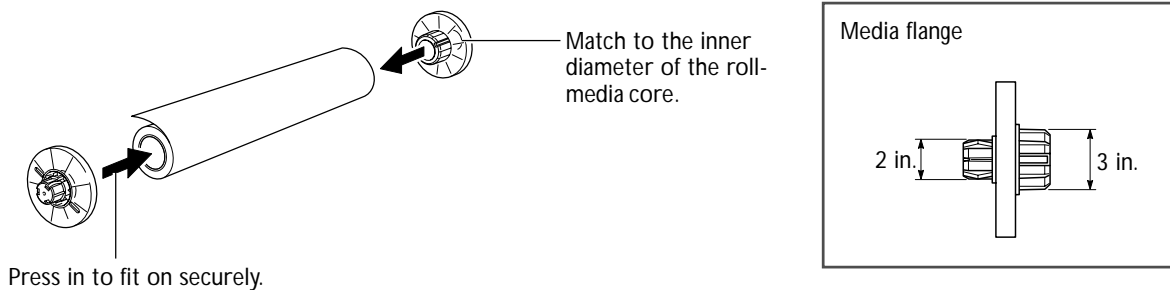

### 3 Place the roll media on the shafts. Make sure the brake is engaged when you do this.

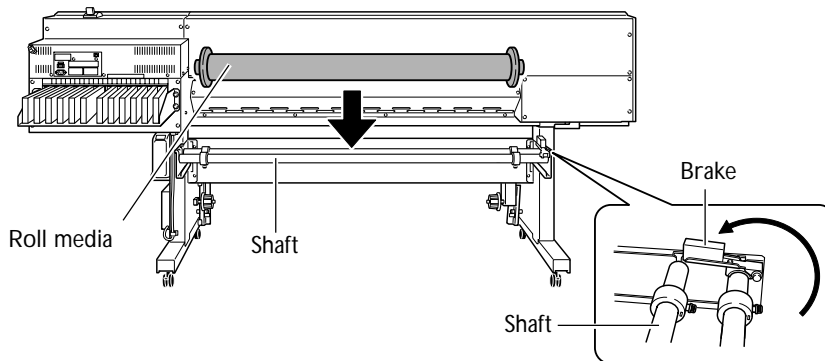



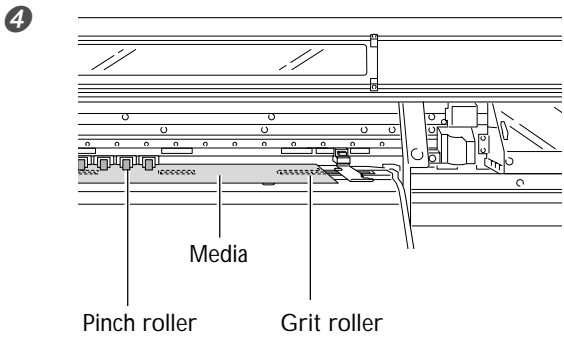

Pass the media between the pinch rollers and the grit rollers, bringing the end of the media as far as the platen.

## 2. Align the media.

1 Position so that both edges of the media are aligned above the grit rollers, and move the pinch rollers to position them above the grit rollers.

Move the entire roll media to perform positioning.  
The pinch rollers cannot be lowered at any position other than above the grit rollers. You can vary the number of middle pinch roller used according to the width and composition of the media. Increasing the number used makes media feed correspondingly more stable.

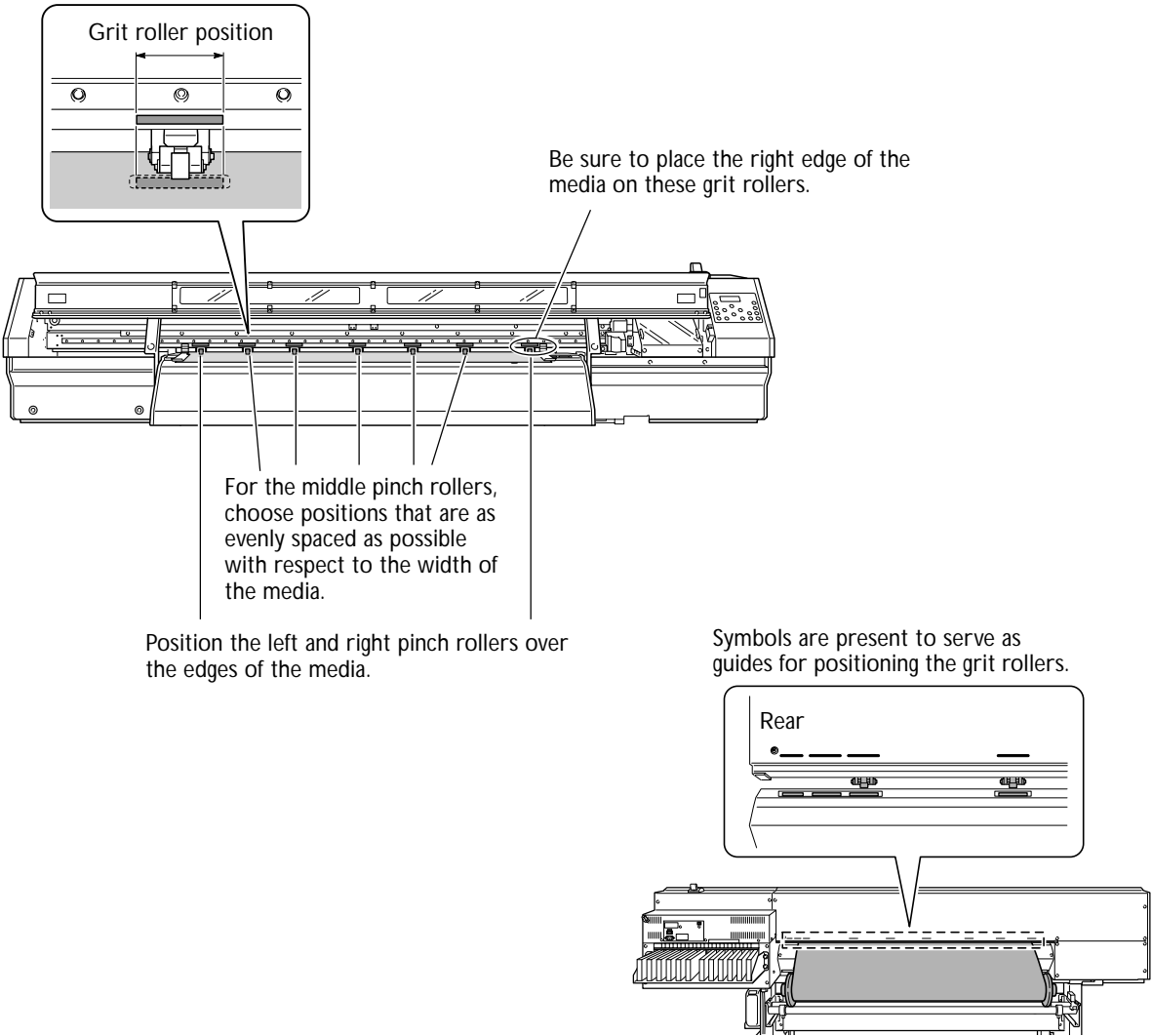

- ② Secure the stoppers in place in alignment with the width of the media.  
The stoppers number four in total. Tighten all screws.

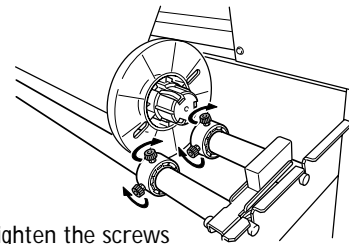
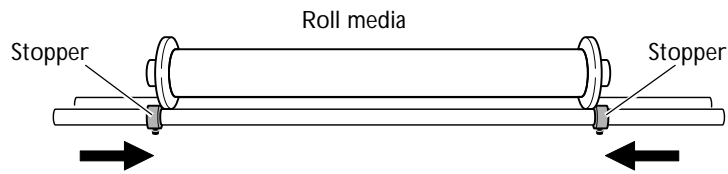

Tighten the screws to secure in place.

### **Important!**

Make sure the media flanges are straight. Correct media feed is impossible if either of the media flanges is at an angle.

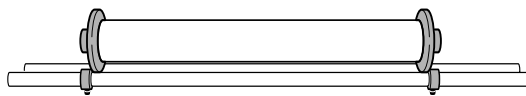

OK

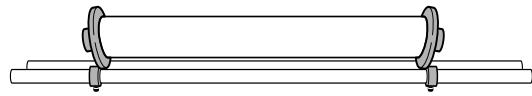

Not OK

### 3. Load the media so that it is without slack.

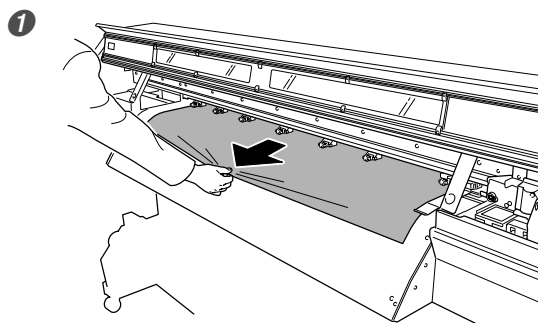

Pull out the media.

Hold the media at the center and pull it out, being sure to keep it straight.

Make sure all areas of the media are taut.

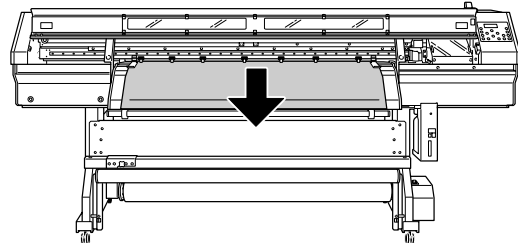

OK



Not OK

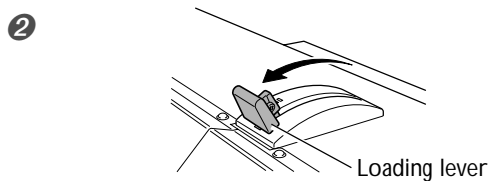

Pull back the loading lever to secure the media in place.

**4. Set the media clamps and close the front cover.**

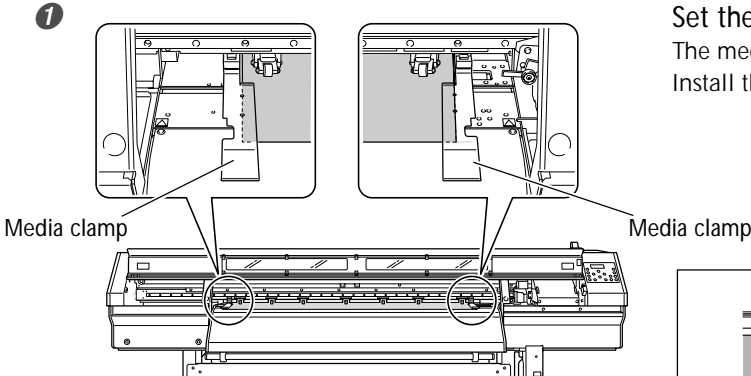

Set the media clamps.  
The media clamps have distinct left and right sides. Install them like shown in the figure.

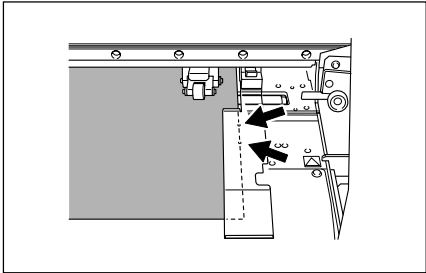



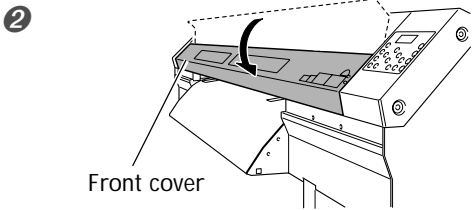

Line up the hole with the end of the media



Close the front cover.



Use   to select [ROLL].  
Press .

4 Press .

**Important Note When Using the Media Clamps**

Insert the media clamps firmly all the way until they engage with an audible click, and make sure they will not come loose. Incorrect mounting may cause the media to catch or snag and make correct printing impossible, or may lead to malfunction or poor output quality.

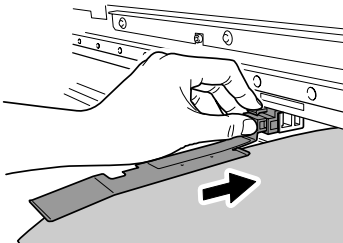

### ***Position the pinch rollers over the grit rollers.***

If the following message appears when you close the front cover, open the front cover and check the positioning of the pinch rollers. These must be placed over the grit rollers.

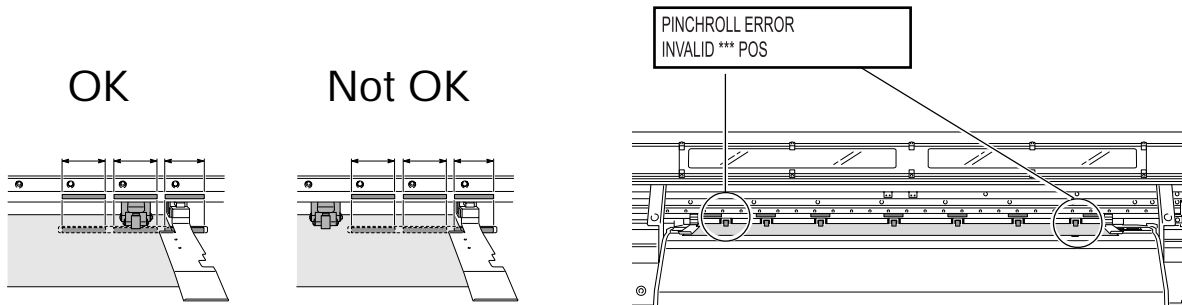

### ***Placement of the Pinch Rollers***

Position the pinch rollers at locations that are not overly close to the edges of the media.

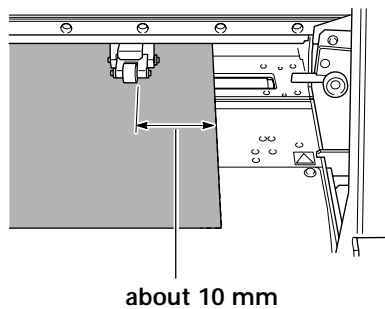

### ***Remove when not using roll media.***

If roll media is allowed to stand unused in a loaded state for an extended period, the media may sag. This can cause poor output quality and motor errors, so be sure to remove and properly store such media when not in use.

## How to Cut Off Media

### Procedure

1

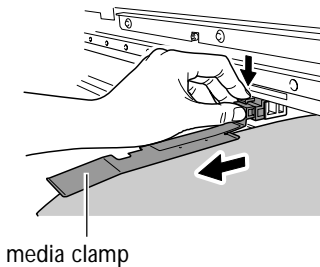

Open the front cover.  
Detach the media clamps.

2

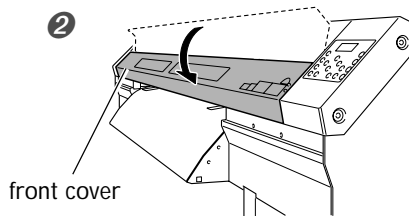

Close the front cover.

3 Make sure the **SET UP** lights up.

4

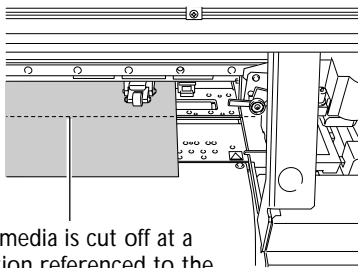

Hold down **SHEET CUT** for one second or longer.

**SHEET CUT**



### Cut-off Operations

Before you perform cutoff, be sure to detach the media clamps. .

Performing cutoff with the media clamps remaining attached may cause the operation to be interrupted due to detection of the media clamps.

**When you're performing cutoff, never use the **▲** to pull the media back.**

Unless the end of the media has been pulled out to a location to the front of the platen, cutoff may not be performed smoothly.

## 2-3 Settings of the Media Heating System

### What Is the Media Heating System?

This machine is equipped with a media heating system that warms the media. You use this mainly to improve ink adhesion and dry the ink. You can adjust the temperature settings to match the type of media and the printing speed.

#### Preheater

This device warms the media before printing.

#### Print heater

This device is used mainly to improve ink adhesion.

#### Dryer

You use this to warm the media after printing and speed up ink-drying.

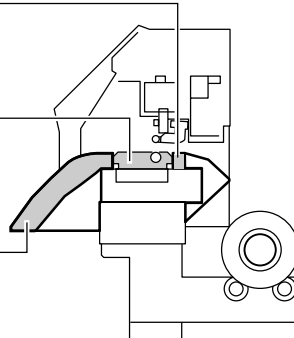

- ⚠ WARNING** **Caution: high temperatures.**  
The platen and dryer become hot. Exercise caution to avoid fire or burns.
- ⚠ WARNING** **Remove any loaded media or switch off the sub power when printing is not being performed.**  
The continued application of heat at a single location may cause fire or produce toxic gases.
- ⚠ WARNING** **Never use media that cannot withstand the heat.**  
Doing so may result in fire or the release of toxic gases, or may degrade the media.
- ⚠ WARNING** **Never use the platen or dryer for any purpose for which they are not intended, such as to dry clothing.**  
Doing so may cause overheating, resulting in fire or accident.

### Making the Temperature Setting for the Media Heating System

#### Procedure

- 1**

PRE	40	PRINT	40
DRY	50		

 Press **HEATER CONFIG**.  
The present temperature is displayed.
- 2**

DRYER	50	◀▶
	50	▶ 50◀

 Press **HEATER CONFIG** a second time.  
Use **◀ ▶** to select the unit.
- 3**

DRYER	50	◀▶
	50	▶ 55◀

 Use **▲ ▼** to make the setting.  
Press **ENTER** to enable the setting.
- 4**

W 1346mm
SETUP SHEET
◀▶ ROLL

 Press **MENU**.  
Press **◀** to go back to the original screen.

By default, simply switching on the power does not make the machine warm up to the preset temperature. Pressing **SET UP** to make the light come on makes them to warm up to the preset temperature.

## General Guide for the Preset Temperatures

The optimal temperature for the media heating system varies according to such factors as the type of media and differences in the print mode. Use the following as a general guide and adjust accordingly.

---

### General Guide for Adjustment

---

#### Preheater

Set this to a temperature that is the same as or lower than the temperature of the print heater.

You use the preheater mainly to heat media gradually. This is because media becomes more likely to shrink or wrinkle if heated suddenly.

#### Print heater

You use this mainly to improve ink adhesion and inhibit smudging.

If the ink forms lumps or smudges, raise the temperature. Note, however, that a temperature that is too high may degrade the media or cause it to wrinkle.

#### Dryer

When ink drying is poor, raise the temperature. Note, however, that a temperature that is too high may degrade the media or cause it to wrinkle.

#### The relationship between the print mode and temperature

If smudging or poor drying occur even after raising the temperature, try using a print mode offering higher image quality. Conversely, when you want to use a faster print mode, raise the temperature.

#### Amount of ink

When you change the amount of ink using the settings for your software RIP, adjusting this may yield better results. If problems such as smudging persist even after raising the temperature, try reducing the amount of ink.

---

### *Use at an ambient temperature of 20 to 32°C (68 to 90°F).*

---

If the machine is used at an ambient temperature less than 20°C (68°F), then depending on the type or width of the media, wrinkling or temperature-caused unevenness may occur. To obtain stable printing results the machine should be used at an ambient temperature of 20 to 32°C (68 to 90°F).

### Examples of Preset Temperatures

---

Media	Temperature
Type: Scrim banner (PVC) Thickness: 300 to 400 $\mu\text{m}$ (12 to 16 mil)	Preheater: 40°C (104°F) Print heater: 40°C (104°F) Dryer: 50°C (122°F)
Type: Marking film (PVC, with adhesive) Thickness: 60 to 100 $\mu\text{m}$ (2.5 to 4 mil, not including backing paper)	Preheater: 35°C (90°F) Print heater: 35°C (90°F) Dryer: 50°C (122°F)

- These are only rough estimates. Make adjustments to match the media you're using.
- Using the media heating system does not necessarily make it possible to apply ink to every kind of media. Be sure to test in advance.
- Results may vary greatly depending on the print mode and other factors. Make settings suited to the media.
- When suggested settings for temperature, print mode, and other values are given, use the suggested settings.



# 2-4 Starting Output

## Getting Ready to Receive Data from a Computer

When you have finished loading media and making the temperature settings for the heating devices, then follow the steps below. This procedure enables the machine to receive data from the computer and perform output.

Note, however, that when you want to perform only cutting, operation that differs from the following procedure is required.

☞ P.46 "To Perform Cutting"

### Procedure

- 1 Close the front cover.
- 2 Press **SET UP** (making the light come on).
- 3 Wait until **HEATER CONFIG** stops flashing and stays steadily lit.
- 4 Make sure you are at the top menu.  
If you are not at the top menu, press **MENU**, then press **◀**.

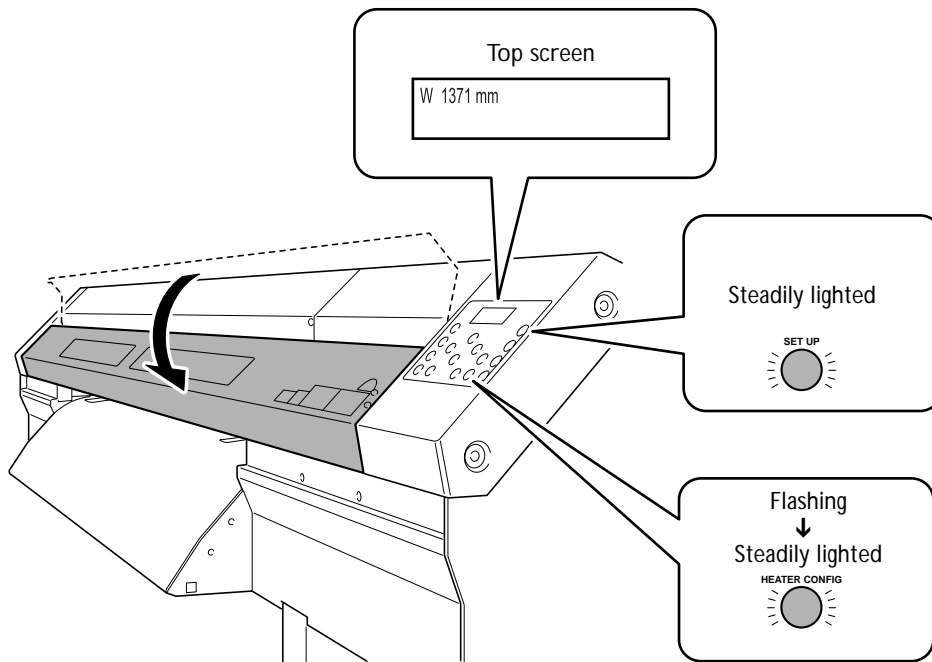

### Outputting Is Not Possible in These Situations

- The machine does not run when the front cover is open. Also, never open it when output is in progress. Doing so interrupts output.
- Data from the computer is not accepted when **SET UP** is dark.
- Printing does not start until **HEATER CONFIG** lights up.
- Data from the computer is not accepted when you are not at the top menu.

### Points Which Must Be Observed

- Be sure to set the media clamps during printing. Otherwise the edges of the media may warp and catch on the print heads.
- During output, never touch the media that's already been discharged. Doing so may obstruct media feed or cause the media to rub against the heads, which may result in a paper jam or damage to the heads.

## Printing Tests and Cleaning

We recommend performing a printing test to check for problems such as dot drop-out before you carry out actual printing. If problems such as dot drop-out are found, clean the print heads.

### How to Perform a Printing Test

Hold down for one second or longer.

**TEST PRINT**



Printing test

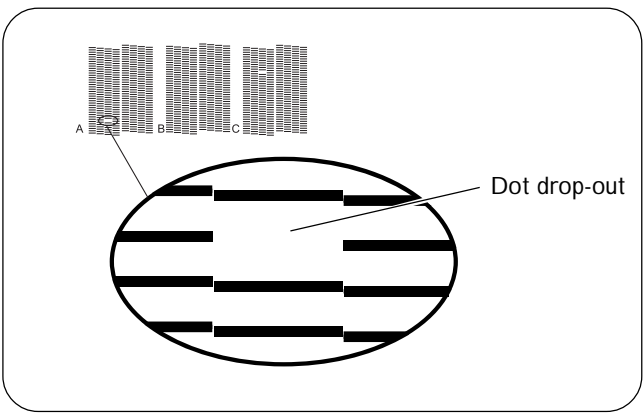

**BASE POINT**

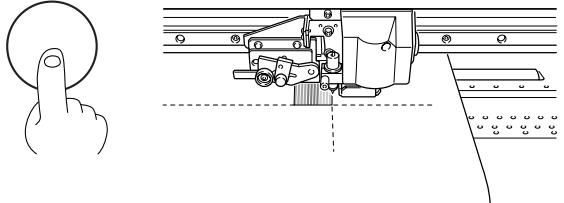

Holding down **TEST PRINT** for one second or longer prints a test pattern.

You can print the test pattern where you want by using **◀** **▶** **▼** to move the cutting carriage, then pressing **BASE POINT**. The front cover may be open during movement, but be sure to close it before you press **TEST PRINT**.

## How to Perform Cleaning

When a printing test reveals dot drop-out or the like, perform cleaning for just the group of a head that is incapable of correct printing. Compared with performing cleaning for all heads, this can reduce the amount of ink consumed.

### Procedure

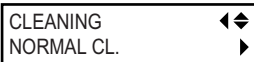
1 

Press .



2 

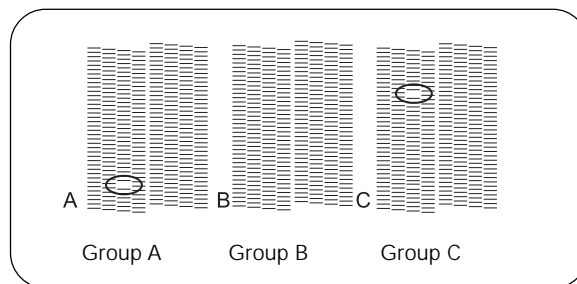

Press .

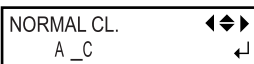

Test print

3 

Use   to choose the group of a head that is not to be cleaned.

Use   to get rid of the group display.

Repeat this procedure to display the groups of only the heads that require cleaning.

Of groups A through C, cleaning is performed only for the groups displayed.

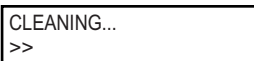

4 

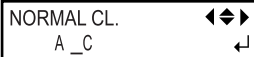
Press .  
Cleaning starts.

When it finishes, the screen shown in the figure appears again.

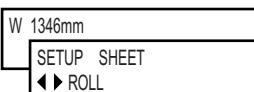
5 

Press .  
Press  to go back to the original screen.

6 Perform a printing test again to make sure the dot drop-out has been corrected.

If the problem persists, try performing cleaning a second time.

If the problem doesn't go away even after performing cleaning two or three times, then try cleaning using a different method.

 P.66 "When Head Cleaning Is Not Effective"









### When you want to clean all heads simultaneously

Hold down  for one second or longer. Cleaning for all heads starts automatically.

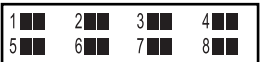
# 2-5 If Ink Runs Out

## Checking for Remaining Ink

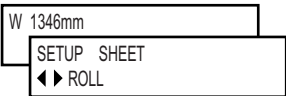
### Procedure

-  Press  .  
Press  several times.
-  Press  .
-  Press  .
-  Press  .  
Press  to go back to the original screen.

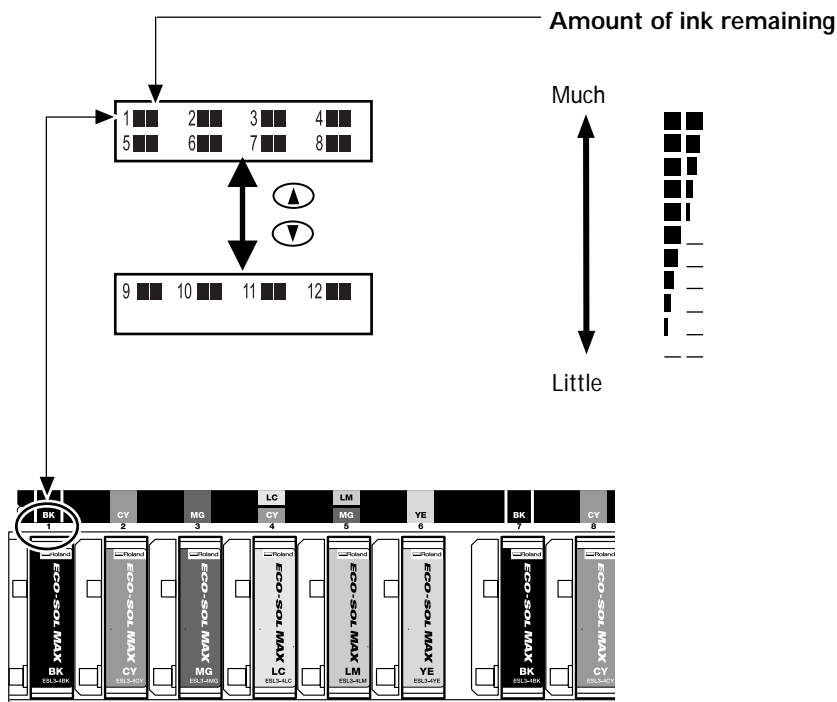

The display shows an approximate guide to the amount of remaining ink, which may differ somewhat from the actual amount remaining. Also, the displayed information may differ greatly from the actual amount remaining if you insert a partly used ink cartridge or change cartridges while the power is off.

## If Ink Runs Out

When ink runs out, a warning beep sounds and printing pauses (unless the default settings have been changed). Pull out the empty cartridge and insert a new one. Printing resumes.

### Procedure

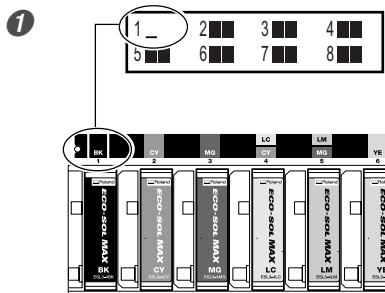

The slot number for the empty cartridge flashes.

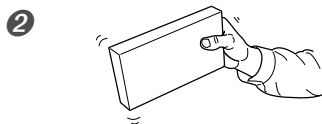

Gently shake the new cartridge.

3 Pull out the empty cartridge and immediately insert the new one.

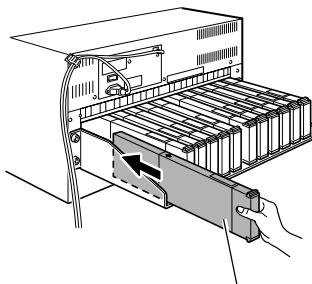

- Keep the labeled side face up.
- Insert and remove slowly, one at a time.
- Insert firmly, as far as it will go.

Replace with an item of identical type and color.

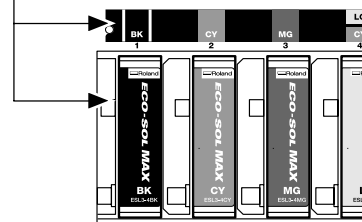

### Important Notes on Replacing Cartridges

- Be sure to replace with an item of identical type. Never mix items of different types.
- Never allow the machine to stand with an ink cartridge removed. The print heads may become clogged.
- Never insert or remove a partially used ink cartridge.
- Never remove an ink cartridge suddenly while the printer is in operation.
- When printing is paused, the coloring at the seam may be altered when printing resumes. Before you perform lengthy printing, check the amount of ink remaining in the ink cartridges.

**⚠ WARNING** Never store ink, maintenance fluid, or discharged fluid in any of the following locations.

- Any location exposed to open flame
- Any location where high temperature may occur
- Near bleach or any other such oxidizing agent or explosive material
- Any location within the reach of children

Fire may be a danger. Accidental ingestion by children may pose a health hazard.



# ***Chapter 3***

## ***Using the Cutting Feature***

---

# 3-1 Performing Cutting

## To Perform Cutting

To perform cutting, carry out the procedure described below.

**⚠ CAUTION** Be sure to carry out the operation according to the procedure described. Otherwise a motor error may occur or the roll may fall because the media is pulled with excessive force.

### Procedure

1

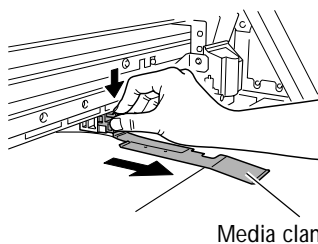
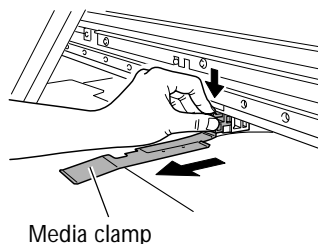

Detach the media clamps.

2

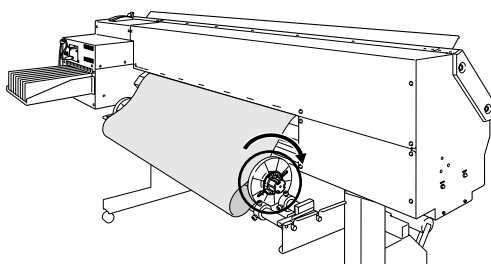

When you're performing cutting only, then if you're cutting roll media, allow the media to hang down from the rear of the machine.

Turn the media flanges by hand to pull out the necessary length from the roll.

### Important Notes on Cutting

- Never use the media clamps. Using them may cause malfunction.
- If you're using the [PREFEED] feature, the media is automatically fed out and taken up again before cutting is performed. This makes it unnecessary to run out media to the rear of the machine before the operation.  
☞ P.93 "Preventing Pulling of the Media with Undue Force When Performing Cutting Only"
- When you're performing cutting, move the dancer roller toward the rear, or detach it. Otherwise media pulled out to the front during lengthy output may interfere with the dancer roller, which may affect output quality.

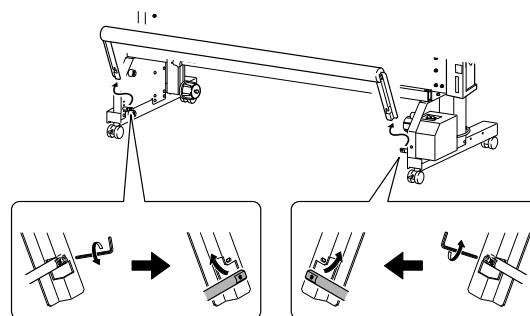



## Performing a Cutting Test

For high-quality cutting, then before you perform actual cutting, we recommend carrying out a cutting test to check the cutting quality for the media. Before carrying out a cutting test, detach the media clamps.

### Performing a Cutting Test

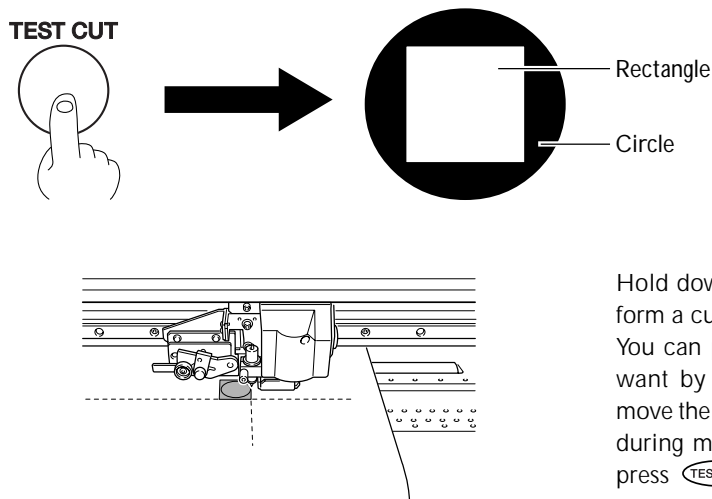

Hold down **TEST CUT** for one second or longer to perform a cutting test.

You can perform the cutting test at any location you want by using **◀** **▶** **▲** **▼** to move the cutting carriage. The front cover may be open during movement, but be sure to close it before you press **TEST CUT**.

Peel off the cut shapes to verify the cutting quality, and make the setting for blade force. For information on how to make the setting, refer to the next clause.

## Making the Setting for Blade Force

### Procedure



Press **CUT CONFIG**.  
Use **▲** **▼** to enter the value.

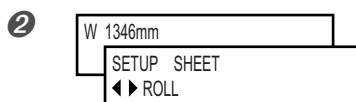

Press **ENTER** to finish making the setting, and go back to the original screen.

Pressing **CUT CONFIG** enters the cutting configuration menu. You can also make the settings for other cutting conditions in addition to the blade force. Refer to the following pages.

☞ P.98 "Fine-tuning the Cutting Conditions"

When you're finished making all the settings, send cutting data from the computer.

☞ P.39 "Getting Ready to Receive Data from a Computer"

## 3-2 Performing Printing Followed Immediately by Cutting

### Performing Printing Followed Immediately by Cutting

You can perform printing and cutting at the same time. When you send data that contains information for both printing and cutting, then after the printing has finished, the cutting operation starts.

#### ***Important!***

---

Set [AUTO ENV. MATCH] to [ENABLE]

☞ P.84 "Making the Setting for Automatic Adjustment of the Printer to the Operating Environment "

Before you start cutting, allow the media to dry thoroughly. If the media is not dry enough, the pinch rollers or the blade may smudge the printed surface during cutting. Drying time may vary according to the type of media or the settings of the media heating system.

Use your software RIP to make the setting for the drying time. For information on how to make the setting, refer to the documentation for the software RIP you're using.

☞ P.36 "Settings of the Media Heating System"

If the lines for printing and for cutting do not match up, alignment for printing and cutting is required.

☞ P.104 "Correcting Misalignment of the Printing and Cutting Positions During Printing Followed Immediately by Cutting"

Depending on the type of media and the temperature of the media heating system, expansion or contraction of the media may cause the positions for printing and cutting to become misaligned. If this happens, use the crop-mark feature to perform alignment for printing and cutting automatically.

☞ P.49 "Cutting Using the Crop-mark Feature"

# 3-3 Cutting Using the Crop-mark Feature

## How to Use the Crop-mark Feature

The crop-mark feature is used for aligning printing and cutting. When you're printing with crop marks in one of the following cases, you can perform automatic alignment with detection of the printed crop marks when you perform cutting.

- When you're cutting media that may have expanded or shrunk during printing due to the heat of the dryer or the like
- When you remove printed media and then reload it and perform cutting (such as when you perform cutting after laminating the media)

### Important Notes When Performing Printing Followed Immediately by Cutting

- When you're performing cutting, switching off the media heating system and allowing the temperature to cool before performing cutting can yield results that are more stable.
  - ☞ P.110 "Switching Off the Preheater, Print Heater, or Dryer"
- The end of the cap for the blade holder may scrape or damage the printed surface. If this happens, increase the amount of blade extension.
  - ☞ P.99 "Accurately Adjusting the Cutting-in Amount"

## Printing with Crop Marks

Use your software RIP to make the settings for printing crop marks. For information on how to make the setting, refer to the documentation for the software RIP you're using. Alignment marks and symbols drawn using a graphics program cannot be used as crop marks.

The crop marks are printed as shown in the figure.

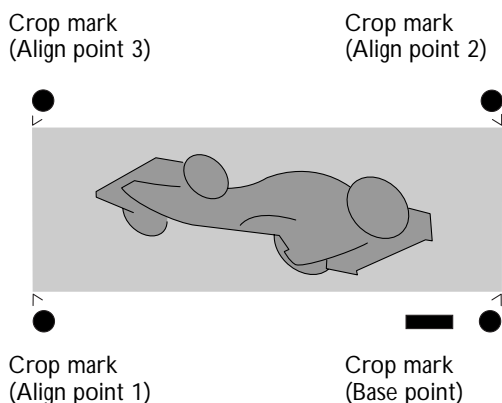

#### Media Sizes Allowing Automatic Crop Mark Detection When Reloading the Media

When you're cutting off media printed with crop marks, reloading it, and performing automatic crop-mark detection, set a margin of at least 90 millimeters before the next print-start position. For other margins, refer to the figure below. You can set the margin value with the software RIP you're using. For information on how to make the setting, refer to the documentation for the software RIP you're using.

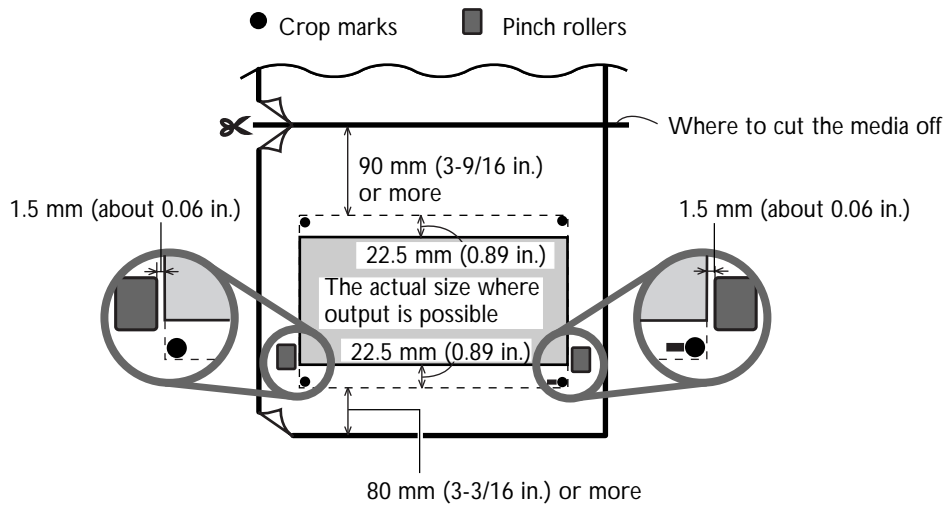

## Performing Cutting with Automatic Crop-mark Detection

When you make the setting for detecting crop marks when sending cutting data from the computer, alignment is performed with the presence or absence of crop marks determined automatically. For information on how to make the settings, refer to the documentation for the software RIP you're using.

When the media has been removed, follow the steps below to reload it.

### Procedure

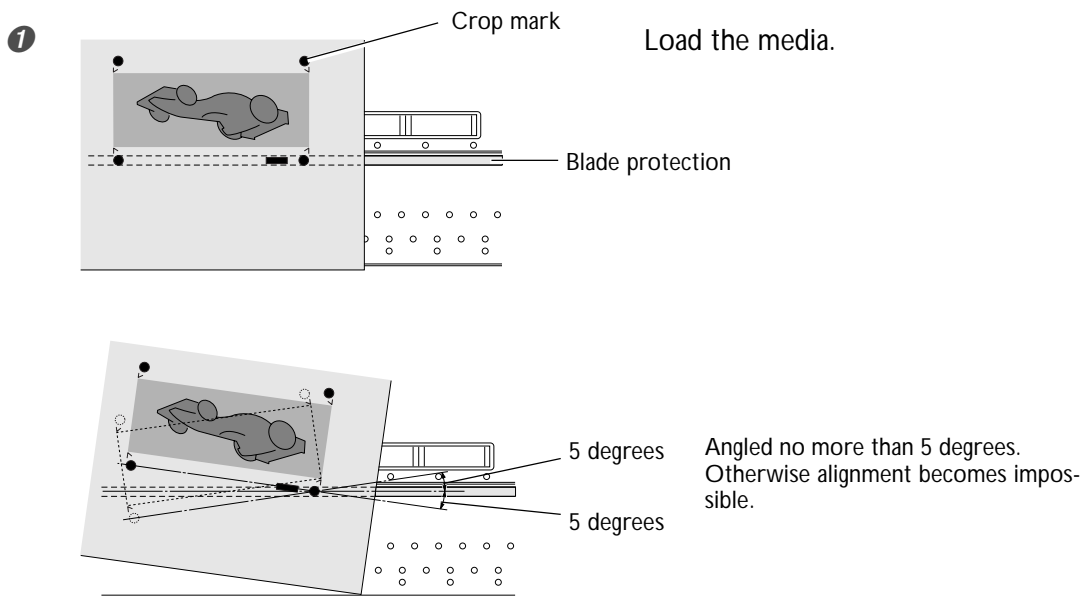

- 2** Send the cutting data.  
Alignment is performed automatically, then cutting starts.

### If Automatic Alignment Cannot Be Performed

If the machine fails to detect the crop marks, the screen shown in the figure appears and operation stops.



If this happens, press **ENTER** key, then take action as follows.



- 1** Reload the media, then send the data again.
- 2** If this does not resolve the problem, then perform alignment manually.

☞ P.52 "Aligning Manually and Cutting"

If the crop marks cannot be detected easily because of the effects of media warping or the like, then perform alignment manually.

When you want to perform automatic alignment with lengthy media, we recommend performing output with the data separated into sizes that are as short as possible. With large sizes, error due to warping and the like increases, making smooth detection impossible.

### To Stop Detection





- 1  Press .
- 2 Press .  
Detection is stopped.

## Aligning Manually and Cutting

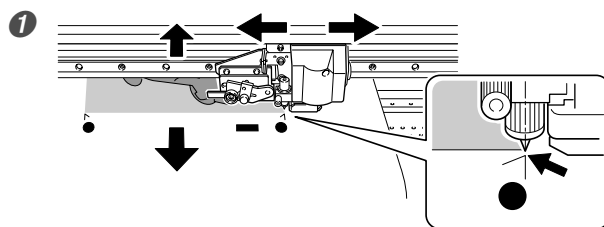
Depending on the type of media, it may not be possible to detect crop marks automatically. When crop marks cannot be detected automatically, you perform alignment manually.

### 1. Set the base point.





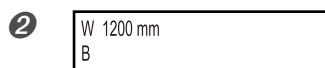

Use     to align the center of the blade with the location shown in the figure.

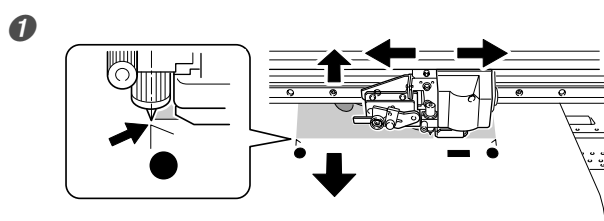

Press .

### 2. Set the align points.



Use     to align the center of the blade with the location shown in the figure.



Hold down  for one second or longer. The number of the align point you set is automatically determined.

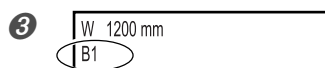

Press .

This indicates that the base point and align point 1 have been set.

- ④ Repeat steps ① through ③ to specify other align points as required.
- ⑤ Send the cutting data and perform cutting.

#### **About Align Points**

The numbers for align points are determined with reference to the location of the base point. You cannot set an align point unless you specify a base point. Redoing the setting for the base point clears any align points that have been set.





***Chapter 4***  
***Operation of the Media***  
***Take-up System***

---

# 4-1 The Take-up System

## Features of the Take-up System

Using the take-up unit lets you perform printing while the media is taken up automatically. This makes possible unattended operation at night and efficient output of lengthy media.

## Operating Conditions for the Take-up System

### *Never Use When Performing Cutting*

---

Never use the take-up unit when you're performing cutting operations. Use is possible only when performing printing.

### *Settings Related to Media Feed*

---

When using the take-up unit, avoid media take-up operations using . Operations that pull the media with undue force, such as unsuitable take-up by the take-up unit, can cause printing to stop or result in misalignment of the printing position.

When you're using the take-up system, be sure to make settings as described below.

- When loading and setting up media, set the [SELECT SHEET] menu item to [TAKE-UP UNIT].
- When feeding out media toward the front of the machine by pressing , be sure to set the base point.
- Set the [PREFEED] setting-menu item to [DISABLE].

### *Important Notes About Automatic Media-cutoff Functions*

---

Do not cut off the media while take-up is in progress. Take-up quits as soon as the media is cut off. Be especially careful when you're printing more than one page.

The setting for turning off automatic cutoff is performed on the computer.

### *Margin Settings*

---

If you can set the margins on the computer, set to 40 millimeters or more.

# 4-2 Using the Take-up System

## How to Take Up Media

### 1. Pass the media through the printer.

1

Move the dancer roller toward the rear.

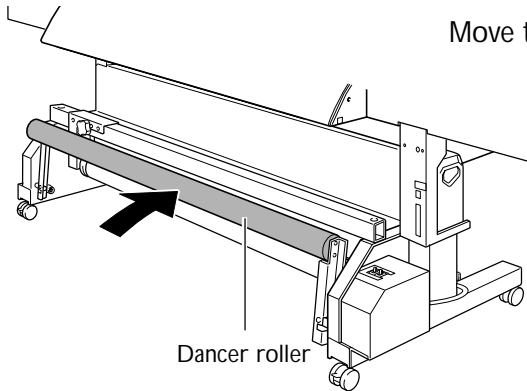

### 2 Load the roll media.

☞ P.30 "How to Load Media"

3

Pull back the loading lever to secure the media in place.

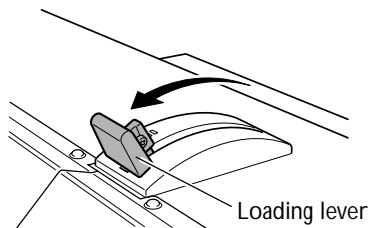

### 2. Fasten the media to the paper pipe.

For information on how to attach the paper tube, refer to the Setup Guide.

1

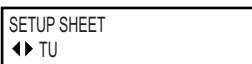

Use ◀ ▶ to select [TU].

Press .

2



Press to adjust the length of the media to be pulled out.

You can adjust the length of the media in 10-millimeter steps by pressing .  
(To pull out media continuously, hold down the key.)

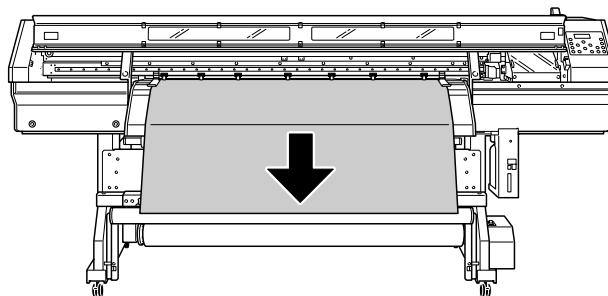

- Fasten the media in place with tape at three locations (the center and both edges) so that the media is not at an angle.

### Take-up with outward curl

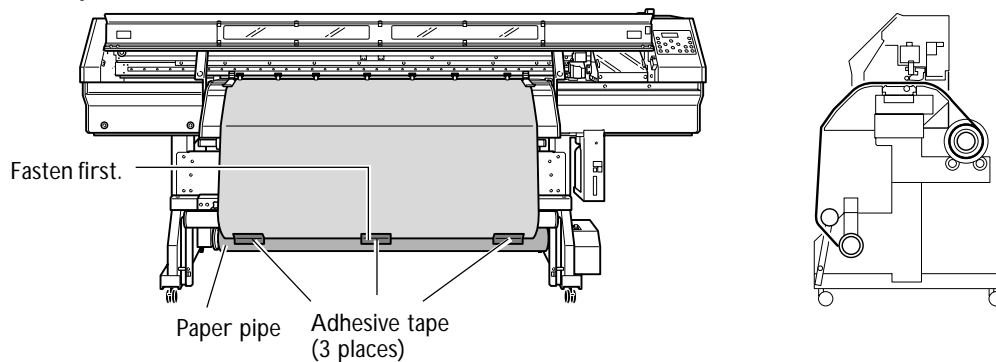

### Take-up with inward curl

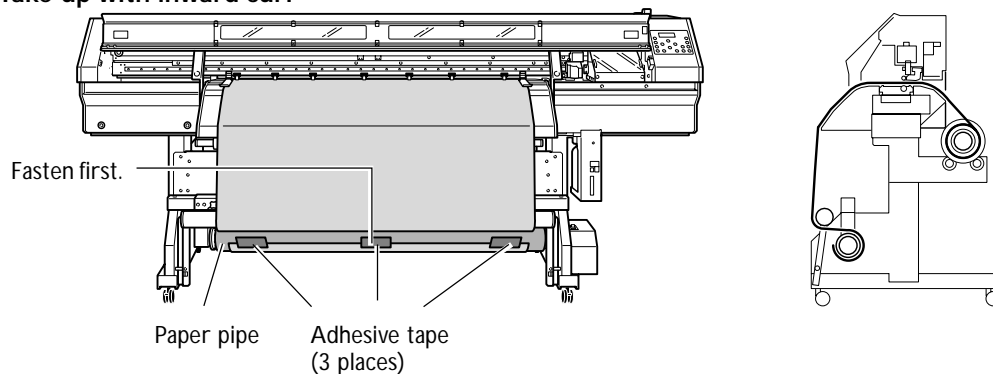

- Press **ENTER**.  
The media is fed out to the front.

- |                             |   |
|-----------------------------|---|
| TILT DANCER ROLLER TO FRONT | ↩ |
|-----------------------------|---|

 Pull the dancer roller back toward you.  
Make sure the media is stretched taut, and press **ENTER**.

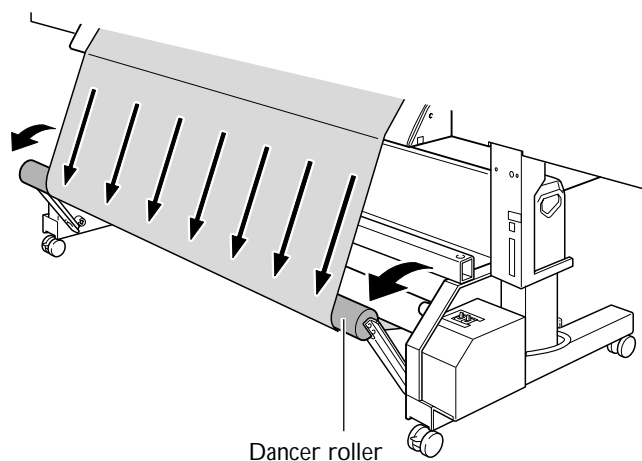

### 3. Make the settings for the take-up unit.

1 CHECK  
TAKE-UP SETTING ↵

Make the setting for the AUTO switch on the take-up unit.

#### Take-up with outward curl

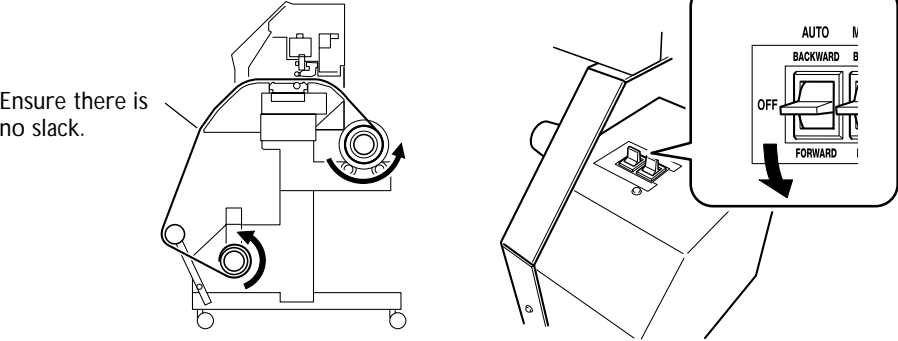

#### Take-up with inward curl

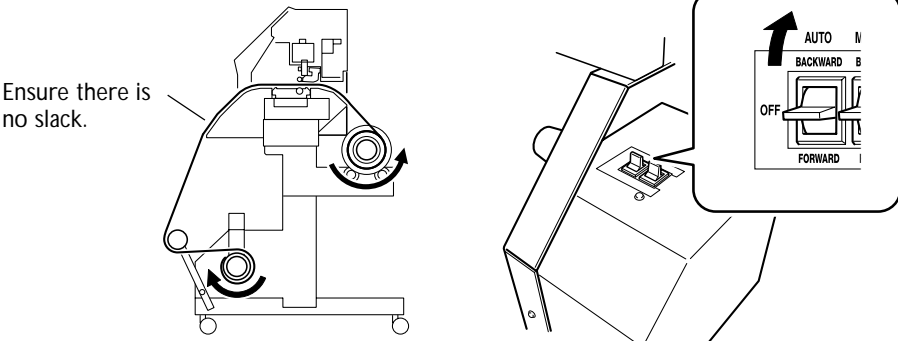

When you begin take-up, take care to ensure that the end of the media does not become rolled or creased.

2 Press ENTER.

3 W 1346mm

Making a setting is complete, when this screen appears.

### How to Operate the MANUAL Switch on the Take-up Unit

You can take up media by using the MANUAL switch.

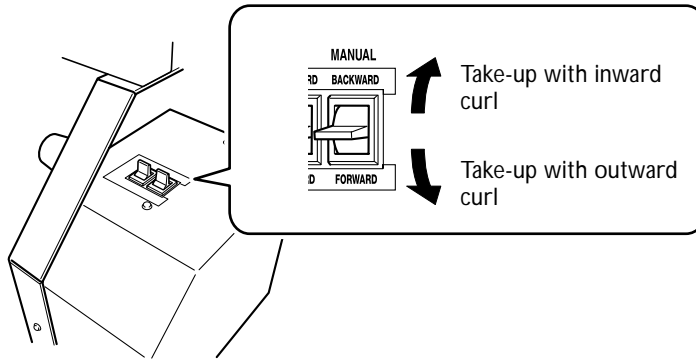

### How to Remove Taken-up Media

**⚠ CAUTION** Removal of taken-up roll media from the unit is a task which must be carried out by two or more persons. Injury may result if attempted by one person without assistance.

#### Removing Taken-up Media

1 Cut off the media.

☞ P.35 "How to Cutoff Media"

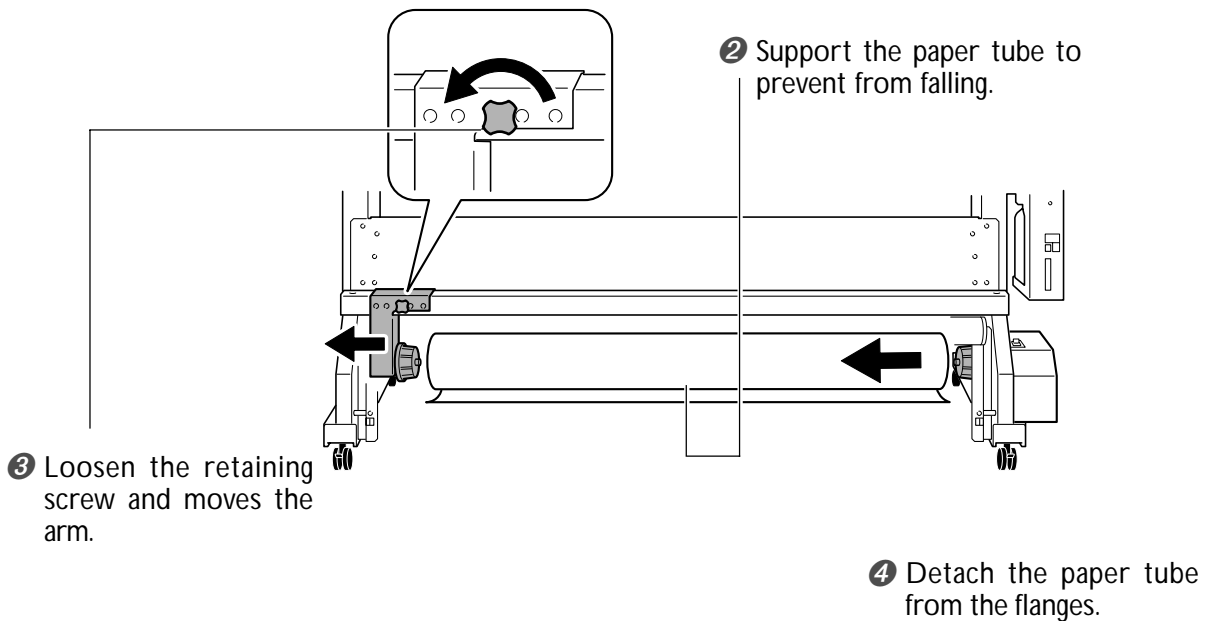

# ***Chapter 5***

## ***Maintenance and Adjustment***

---

# 5-1 Daily Care and Maintenance

## Disposing of Discharged Ink

The drain bottle collects discharged fluid. Dispose of collected material before the bottle becomes full. A message shown in the figure appears when a certain amount of discharged fluid collects in the bottle. Follow the procedure below to discard the discharged fluid.

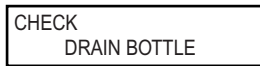

Resetting the discharged-fluid counter after disposal makes the message shown in the figure disappear.

Press **ENTER**.

### 1. Choose the "DRAIN BOTTLE" menu item.



Press **MENU**.  
Press **▼** several times.



Press **▶**.  
Press **▲**.



Press **▶**.  
Press **▲**.



Press **ENTER**.  
Preparations are complete when this screen appears.

### 2. Empty the bottle by discarding the discharged fluid.

**CAUTION** Before you detach the drain bottle, be sure to wait for the screen to display "EMPTY DRAIN BOTTLE."

Failing to follow this procedure may cause discharged fluid to flow out of the tube and spill, soiling your hands or the floor.

**Upper limit**  
Discard before  
this is reached.

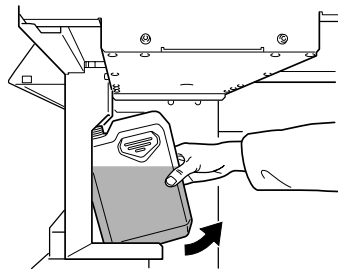
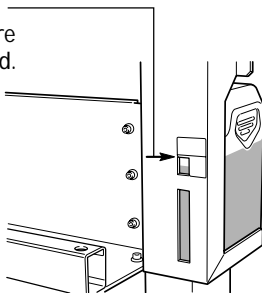



### 3. Attach the emptied bottle and reset the discharged-fluid count.

1 RESET DRAIN  
COUNTER ↵

Press **ENTER**.

2 MAINTENANCE  
DRAIN BOTTLE ↵

Press **ENTER** a second time.

3 W 1346mm  
SETUP SHEET  
◀▶ ROLL

Press **MENU**.  
Press **←** to go back to  
the original screen.

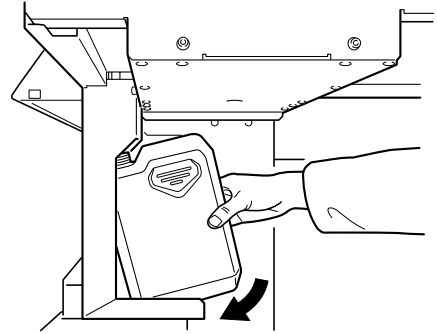

**⚠ WARNING** Never store discharged fluid in any of the following locations.  
Doing so may cause fire.

**⚠ CAUTION** To store discharged fluid temporarily, place it in the included drain bottle or in a durable sealed container such as a metal can or polyethylene tank, and cap tightly. Any spillage or vapor leakage may cause fire, odor, or physical distress.

Dispose of discharged fluid properly, in accordance with the laws in effect in your locale. Discharged fluid is flammable and contains toxic ingredients. Do not attempt to incinerate discharged fluid or discard it with ordinary trash. Also, do not dispose of it in sewer systems, rivers, or streams. Doing so may have an adverse impact on the environment.

## Cleaning

### Pinch rollers

Periodically wipe away any grime. Failure to clean properly may result in the transfer of grime to the surface of media.

### Grit rollers

Remove buildup of media and other material using a brush. Never use a metal brush.

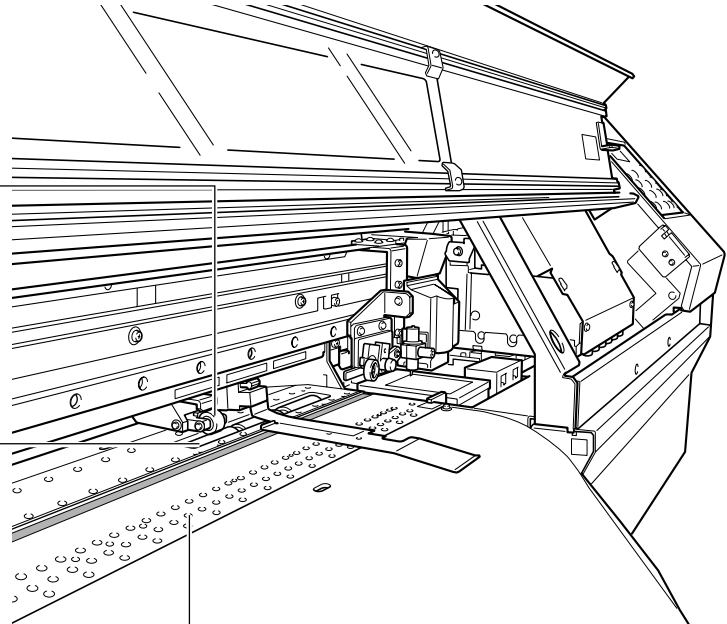

Wipe away any buildup of ink or grime on the media path.

**⚠ WARNING** Never use gasoline, alcohol, thinner, or any other flammable material. Doing so may cause fire.

**⚠ CAUTION** Before attempting cleaning, switch off the sub power and wait until the platen and dryer cool (approximately 30 minutes). Sudden movement of the machine may cause injury, or hot components may cause burns.

- This machine is a precision device, and is sensitive to dust and dirt. Perform cleaning on a daily basis.
- Clean by wiping with a cloth moistened by neutral detergent diluted with water then wrung dry.
- Never attempt to oil or lubricate the machine.

## Care and Maintenance of the Print Heads

---

### Daily Care and Maintenance

---

Perform maintenance using the machine's head cleaning feature.

- ☞ P.40 "Printing Test and Cleaning", P.66 "When Head Cleaning Is Not Effective"

---

### Periodic Care and Maintenance

---

Periodic care is essential to ensuring optimal printing at all times. Based on your frequency of use, periodically clean the heads using a cleaning kit.

- ☞ P.68 "Cleaning the Heads Using the Cleaning Kit"

Note: The print heads are components that wear out. Periodic replacement is required, with the frequency of replacement depending on use. Purchase them from your authorized Roland DG Corp. dealer.

# 5-2 When Head Cleaning Is Not Effective

## Performing More Powerful Cleaning

When the problems such as dot drop-out are not cleared up by the "normal cleaning," try the more forceful "medium cleaning" or the even more forceful "powerful cleaning." Note, however, that this consumes more ink than "normal cleaning," and too-frequent use may damage the print heads themselves. Avoid using it more than necessary. In the same way as for normal cleaning, choose and clean only the group of a head that are incapable of correct printing.

### 1. Choose "medium cleaning" or "powerful cleaning."

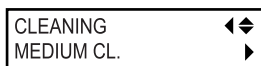

Press .  
Press to choose "MEDIUM CL." or "POWERFUL CL.".

### 2. Specify the head group to clean.

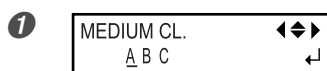

Press .

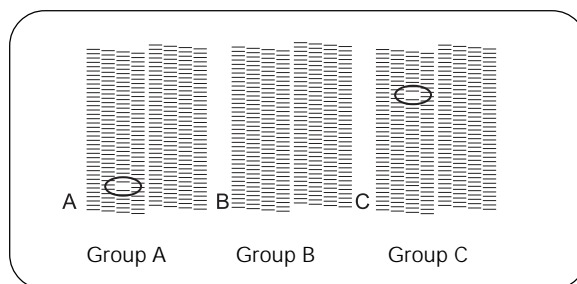

Printing-test results

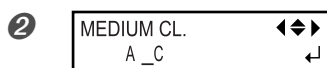

Use to choose the group of a head that is not to be cleaned.

Use to get rid of the group display.

Repeat this procedure to display the groups of only the heads that require cleaning.

Of groups A through C, cleaning is performed only for the groups displayed.

### 3. Start cleaning.

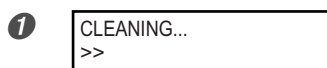

Press .  
Cleaning starts.

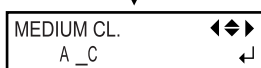

When it finishes, the screen shown in the figure appears again.

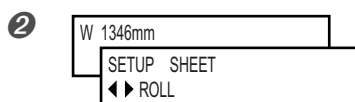

Press .  
Use to go back to the original screen.

## When Powerful Cleaning Is Not Effective

If problems such as dot drop-out persist even after you have performed powerful cleaning several times, then use the cleaning kit to clean the heads. Such cleaning can be effective when carried out periodically, according to the frequency of use.

☞ P.68 "Cleaning the Heads Using the Cleaning Kit"

# 5-3 Cleaning the Heads Using the Cleaning Kit

## When the Cleaning Kit Becomes Necessary

### Periodic Care and Maintenance

Use the cleaning kit to perform head-cleaning periodically, according to the frequency of use.

### When dot drop-out or the like occur frequently

When the machine's head-cleaning feature does not correct the problem, clean the heads using the cleaning kit.

- If you use up the cleaning kit, purchase a new one from your authorized Roland DG Corp. dealer.
- The print heads are components that wear out. Periodic replacement is required, with the frequency of replacement depending on use. Purchase them from your authorized Roland DG Corp. dealer.

## How to Perform Cleaning

### Important Notes on This Procedure

- Before attempting this operation, remove any media.
- To prevent the heads from drying out, finish this procedure in 30 minutes or less.
- A warning beep sounds after 30 minutes. At this time, stop work, attach the front cover, and press **ENTER**. When the head-protection operation finishes, restart the procedure from the beginning.
- Never use any implement other than the included cleaning stick. Cotton swabs or other lint-producing items may damage the heads.
- Never touch the nozzle surface of the heads.
- Stroke the sponges very gently, applying as little pressure as possible. Never rub, scrape, or crush them.

**⚠ CAUTION** Be sure to perform operations as specified by these instructions, and never touch any area not specified in the instructions. Sudden movement of the machine may cause injury.

## 1. Change to the print-head manual-cleaning mode.



Press **MENU**.  
Press **▼** several times.



Press **▶**.  
Press **▲**.



Press **▶**.



Press **ENTER**.

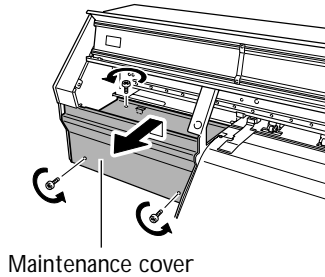

Open the front cover and remove the maintenance cover.



Close the front cover.

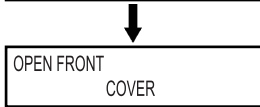

Press **ENTER**.  
The print-head carriage moves to the left side of the machine, and then the screen shown in the figure appears.

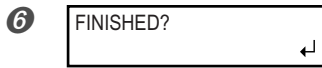

Open the front cover.  
Preparations are complete when this screen appears.

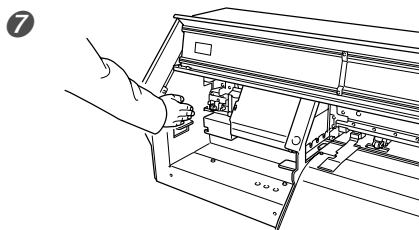

Touch the location shown in the figure to discharge any static electricity.

**2. Clean using the cleaning stick. Be especially careful to clean away any fibrous dust (lint).**

Clean in the sequence shown in the figure below.

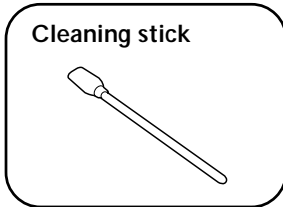

Be sure to clean using one of the included cleaning sticks.

 **Never touch the nozzle surface.**  
Clean only the metal frame.

Gently stroke the sponge.  
**Never rub with force.**

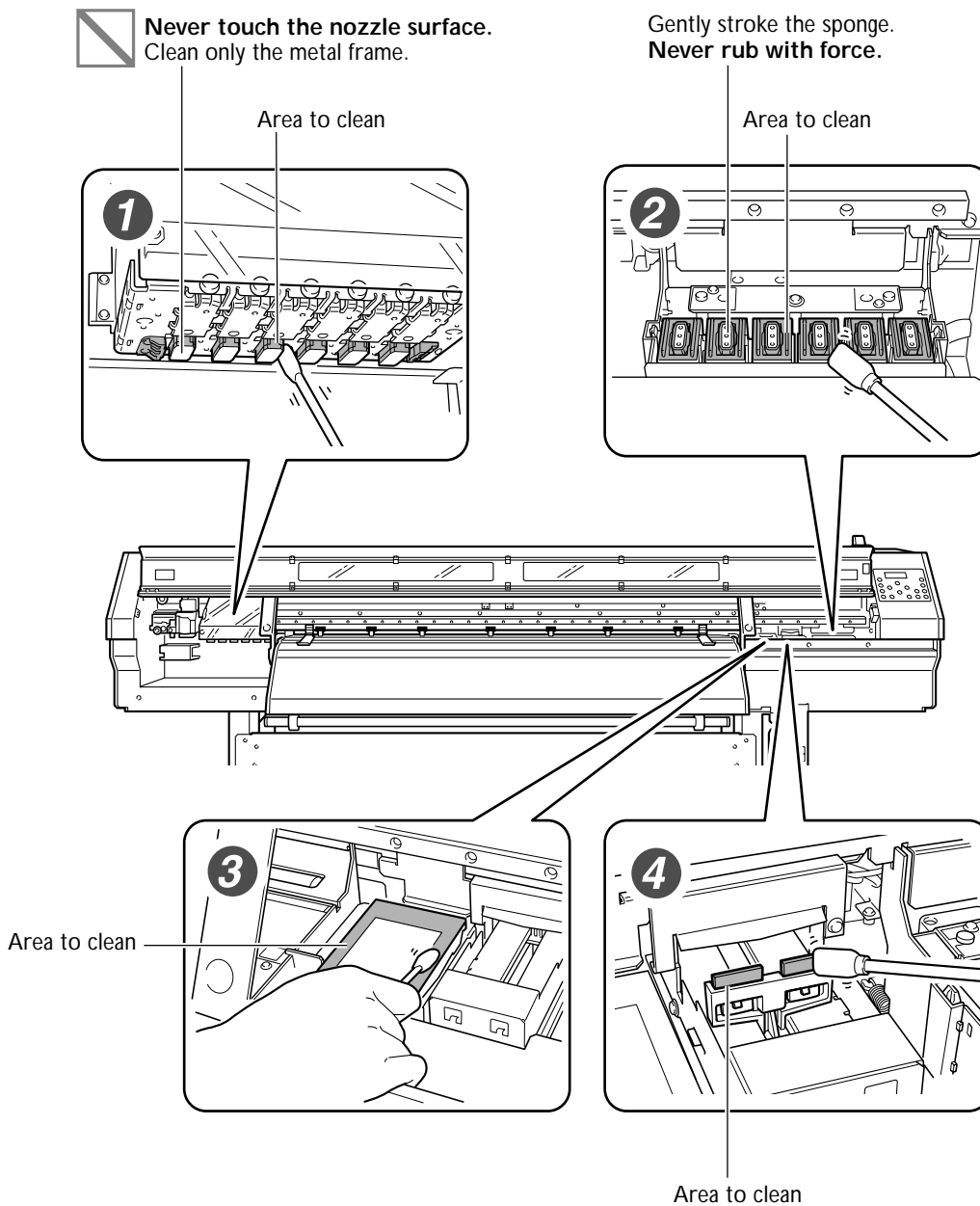



### 3. Quit the manual cleaning mode.

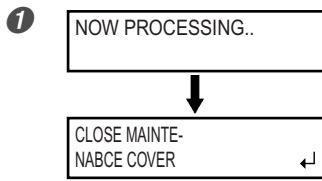

Close the front cover.

Press **ENTER**.

The print-head carriage moves to the right side of the machine, and then the screen shown in the figure appears.

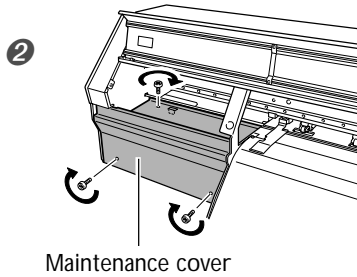

Open the front cover and close the maintenance cover.

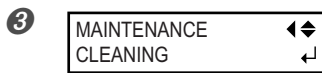

Close the front cover.

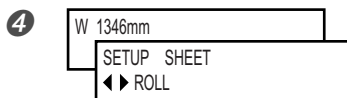

Press **MENU**.

Press **◀** to go back to the original screen.

### 4. Perform a printing test to verify the results of the procedure.

Perform a printing test to check the results.

Perform cleaning several times as required.

☞ P.40 "Printing Test and Cleaning"

# 5-4 Replacing Consumable Parts

## Replacing the Wipers

The wipers are components that you use when cleaning the print heads. When the screen displays a message like the one shown, it means the item needs to be replaced. Replace with new items.



Press **ENTER**.

### Important Notes on This Procedure

- > To prevent the heads from drying out, finish this procedure in 30 minutes or less.
- > A warning beep sounds after 30 minutes. At this time, stop work, attach the right side cover, and press **ENTER**. When the head-protection operation finishes, restart the procedure from the beginning.

**CAUTION** Be sure to perform operations as specified by these instructions, and never touch any area not specified in the instructions. Sudden movement of the machine may cause injury.

### 1. Display the [REPLACE WIPER] menu.



Press **MENU**.  
Press **▼** several times.



Press **▶**.  
Press **▲**.

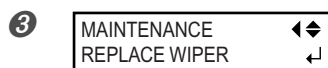

Press **▶**.



Press **ENTER**.  
The print-head carriage moves to a location permitting wiper replacement, and then the screen shown in the figure appears.

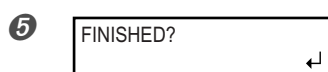
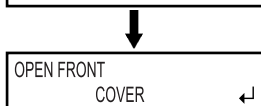

Open front cover.  
Preparations are complete when this screen appears.

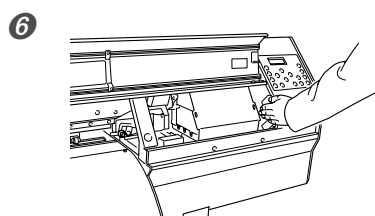

Touch the location shown in the figure to discharge any static electricity.

## 2. Replace the wipers. Use the included tweezers.

1

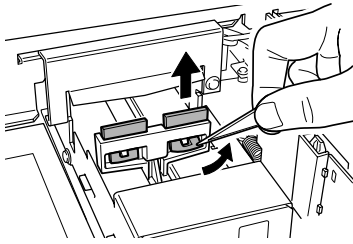

Detach the old wipers.  
Detach the hook and pull up and out.

2

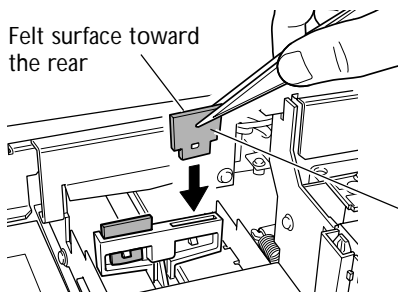

Insert the new wipers.

3

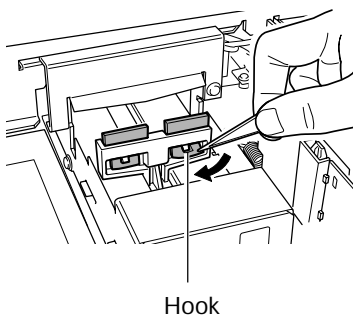

Attach the hook.

## 3. Quit the [REPLACE WIPER] menu.

1

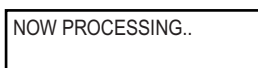

Close the front door.

Press **ENTER**.

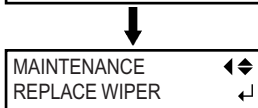

After the process to quit the [REPLACE WIPER] menu ends, the screen shown in the figure appears.

2

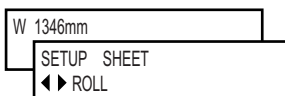

Press **MENU**.

Press **←** to go back to the original screen.

3 Perform a printing test to verify the results of the procedure.

☞ P.40 "Printing Test and Cleaning"







## Replacing the Blade

If the blade becomes dull, replace it with the included replacement blade.

**⚠ CAUTION** Be sure to perform operations as specified by these instructions, and never touch any area not specified in the instructions. Sudden movement of the machine may cause injury.

**⚠ CAUTION** Do not touch the tip of the separating knife with your fingers. Doing so may result in injury.

### 1. Enter the blade replacement mode.

- |                                                                                                                                                                                                                                                                                                  |                                                                                                                                                                                                                                               |
|--------------------------------------------------------------------------------------------------------------------------------------------------------------------------------------------------------------------------------------------------------------------------------------------------|-----------------------------------------------------------------------------------------------------------------------------------------------------------------------------------------------------------------------------------------------|
| <p><b>1</b></p> <div style="border: 1px solid black; padding: 2px; width: fit-content;">             MENU      ◀▶<br/>             SUB MENU    ▶         </div>                                                                                                                                  | <p>Press  .<br/>             Press  several times.</p>                      |
| <p><b>2</b></p> <div style="border: 1px solid black; padding: 2px; width: fit-content;">             SUB MENU    ◀▶<br/>             MAINTENANCE ▶         </div>                                                                                                                                | <p>Press  .<br/>             Press  .</p>                                   |
| <p><b>3</b></p> <div style="border: 1px solid black; padding: 2px; width: fit-content;">             MAINTENANCE ◀▶<br/>             REPLACE KNIFE ◀         </div>                                                                                                                              | <p>Press  .<br/>             Press  several times.</p>                      |
| <p><b>4</b></p> <div style="border: 1px solid black; padding: 2px; width: fit-content;">             NOW PROCESSING..         </div> <p style="text-align: center;">↓</p> <div style="border: 1px solid black; padding: 2px; width: fit-content;">             OPEN FRONT COVER ◀         </div> | <p>Press  .<br/>             The print-head carriage moves to a location permitting blade replacement, and then the screen shown in the figure appears.</p> |
| <p><b>5</b></p> <div style="border: 1px solid black; padding: 2px; width: fit-content;">             FINISHED? ◀         </div>                                                                                                                                                                  | <p>Open the front cover.<br/>             Preparations are complete when this screen appears.</p>                                                                                                                                             |

### 2. Replace the Blade.

- 1** Blade holder      Remove the blade holder.

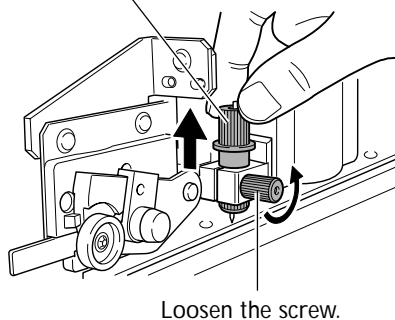

- 2 Press this pin Remove the old blade.

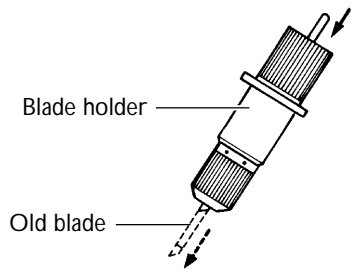

- 3 Push-pin Install a new blade.

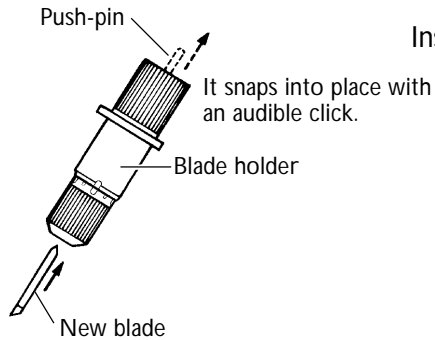

- 4 Reinstall the blade holder.

If installed without supporting the screw in this way, cutting quality may become poor.

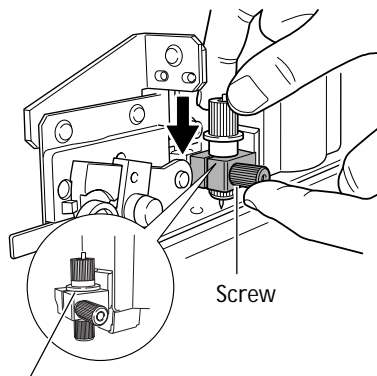

Insert until the collar is flush with the surface.

- 5 Tighten the screw.

Tug the blade holder upward to make sure it does not come loose.

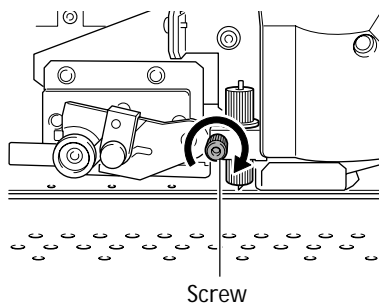

### 3. Quit the [REPLACE KNIFE] menu.

Close the front cover, and press **ENTER**.











## Replacing the Separating Knife

If the separating knife becomes dull, replace it with the included replacement blade.

**⚠ CAUTION** Be sure to perform operations as specified by these instructions, and never touch any area not specified in the instructions. Sudden movement of the machine may cause injury.

**⚠ CAUTION** Do not touch the tip of the separating knife with your fingers. Doing so may result in injury.

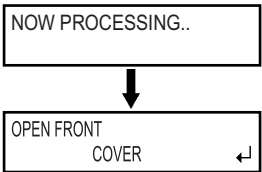
### 1. Enter the blade replacement mode.

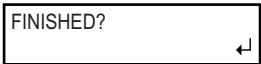
- 1**  Press .  
Press  several times.
- 2**  Press .  
Press .
- 3**  Press .  
Press  several times.
- 4**  Press .  
The print-head carriage moves to a location permitting blade replacement, and then the screen shown in the figure appears.
- 5**  Open the front cover.  
Preparations are complete when this screen appears.

### 2. Replace the separating knife.

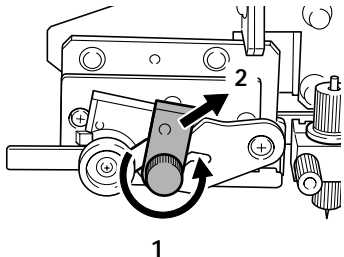
- 1**  Remove the separating knife.

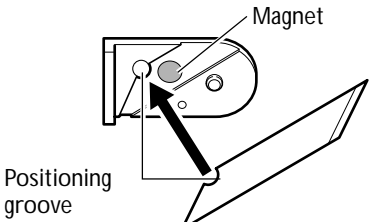
1. Loosen the screw until it slips out.  
2. Grasp the screw portion, and slowly pull it out in the direction of the arrow. When doing this, do not pull it back toward you.
- 2**  Install a new knife.  
The knife is secured in place by the magnet.

3

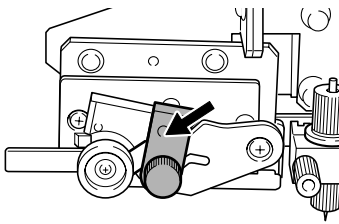

Slowly insert it into the groove.

4

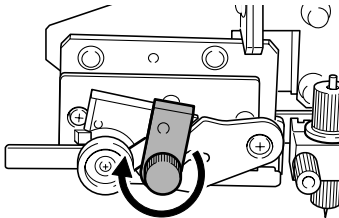

Tighten the screw.  
Take care to ensure that the knife does not slip out of position at this time.

### 3. Quit the [REPLACE KNIFE] menu.

Close the front cover, and press **ENTER**.

# 5-5 When Not in Use for a Prolonged Period

## Keep Performing Maintenance

### Switch On the Power Once a Month

Switch on the sub power once a month. When you turn on the power, the machine automatically performs some operations such as those to keep the print heads from drying out. Allowing the machine to stand completely unused for a prolonged period may damage the print heads, so be sure to switch on the power to perform these automatic operations.

### Keep at a Constant Temperature and Relative Humidity

Even when the machine is not in use, keep it at a temperature of 5 to 40°C (41 to 104°F) and a relative humidity of 20 to 80% (with no condensation). Temperatures that are too high may degrade the ink and cause malfunction. Temperatures that are too low may cause the ink to freeze and damage the heads.

## Alarm Feature



PRESS THE POWER  
KEY TO CLEAN

This function is to remind you to switch on the sub power once a month. When the machine remains unused for about one month, this screen appears and a warning beep sounds. If this screen appears, switch on the sub power. When maintenance operations finish, switch off the sub power.

This feature operates when the printer's main power is turned on. We recommend leaving on just the main power to the printer even when the machine is to remain out of use for a prolonged period.

## Important Note on Draining Ink

This machine has features for draining internal ink and for performing washing using washing cartridges, but they should never be used except in special cases. The machine to stand without ink for a prolonged period may damage the heads, even if internal washing is performed. Once ink has been filled, then as a rule the ink should never be drained.



# 5-6 When Moving the Unit

## Procedures from Preparing to Move Through Reinstalling

To move the machine, you must completely drain all ink inside the machine and secure the print heads in place with Packing materials to protect them. Attempting to move the machine without first doing this may result in damage to internal components due to leaking ink or damage to the heads.

This operation requires eight UNUSED SOL INK cleaning cartridges. Have these on hand before you start.

For information on how to remove and attach the various items, refer to the Setup Guide.

### Important Notes on Moving

- Be sure to use SOL INK cleaning cartridges. Use of any other type may result in breakdown.
- Once the preparations for moving are complete, move the machine and fill it with ink with as little delay as possible. Allowing the machine to stand without ink may damage the heads.
- When moving the machine, keep it at a temperature between 5 to 40°C (41 to 104°F) and at relative humidity between 20 to 80% (with no condensation). Failure to do so may result in breakdown.
- Handle the machine with care when moving, keeping it level (not tilted at an angle) and preventing it from striking other objects.

### 1. Drain the ink and wash the interior.



Press **MENU**.  
Press **▼** several times.



Press **▶**.  
Press **▲** twice.



Press **▶**.  
Press **▼** twice.  
Press **ENTER**.

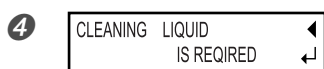

Make sure the cleaning fluid is ready.  
Press **ENTER**.



Press **ENTER**.  
Discard the discharged ink in the drain bottle.

Attach the drain bottle and press **ENTER**.  
Be sure to discard the discharged ink.

- 6 Thereafter, follow the on-screen instructions to carry out the operations.  
After cleaning has finished, switch off the sub power.

☞ P.62 "Disposing of Discharged Ink", P.120 "Draining Ink and Performing Internal Cleaning"

## **2. Secure the print heads in place.**

---

- ❶ Remove the drain bottle and detach the bottle stand. Then attach the drain-tube cover.
- ❷ Detach the blade holder.
- ❸ Raise the loading lever.
- ❹ Secure the print heads in place using the packing material.
- ❺ Lower the roll media from the printer and detach the shafts.  
If necessary, also detach the dancer roller, rail slider and standlegs.  
The machine is now ready to be moved.

## **3. Immediately move the machine and fill it with ink.**

---

- ❶ Once the preparations are complete, move the machine with as little delay as possible.
- ❷ Immediately reinstall the machine and fill with ink.  
To reinstall and fill with ink, go to "Setup Guide." When filling with ink, you use the cleaning cartridges again.

# ***Chapter 6***

## ***Feature Reference***

---

# 6-1 Pausing or Canceling Output

## Canceling Output Before It Finishes

---

### Procedure

---

- 1 Press **PAUSE**
- 2 Hold down **SET UP** for one second or longer.
- 3 Stop sending output data from the computer.

---

### Description





---

**PAUSE** pauses output.  
Pressing **PAUSE** a second time here resumes printing, but a horizontal stripe is produced at the location where printing was stopped. We do not recommend resuming printing.

# 6-2 Setting the Location for Starting Output

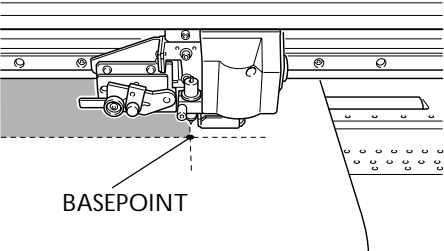

## Setting the Output-start Location

### Procedure

- 1  Use     to move the cutting carriage. Align the center of the blade with the new output-start location.

- 2 Press 

### Description











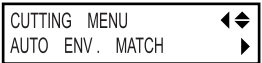

You can use  to set the output-start location anywhere you want. Note, however that this setting must be made for each individual page. When the printing of one page finishes, the output-start location returns to its default value. When the location has been set, the  comes on. Also, the screen displays the printable width at the set location.

When using the take-up unit, never use . Doing so may cause the take-up unit to pull the media with undue force, resulting in an error or malfunction.

# 6-3 Matching the Printer to the Operating Environment

## Making the Setting for Automatic Adjustment of the Printer to the Operating Environment

### Procedure

- 1  Press .  
Press .
- 2  Press .  
Press .
- 3  Press .  
Use   to select "ENABLE".  
Press  to enable the setting.
- 4  Press .  
Press  to go back to the original screen.

### Description

This setting enables or disables the feature for automatic adjustment to optimize the state of the machine to the environment where it is used (temperature and humidity). It is normally set to "ENABLE."

Performing automatic adjustment can reduce misalignment in the scanning direction (the direction of carriage movement) during printing or cutting.

### Default Setting

[AUTO ENV. MATCH]: ENABLE

# 6-4 Accommodating Various Kinds of Media

## Adjusting Head Height to Match Media Thickness

### Procedure

1 MENU HEAD HEIGHT Press **MENU**. Press **▼** several times.

2 HEAD HEIGHT LOW LOW Press **▶**.

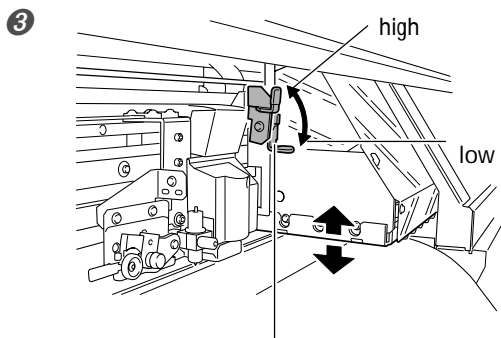

**High-adjustment lever**  
Move firmly, until it stops.

Open the front cover.  
Move the lever to adjust the height of the head.

Moving the lever to "High" makes a warning beep sound twice. Moving it to "Low" makes the warning beep sound once.

4 HEAD HEIGHT LOW HIGH Press **ENTER** to enable the setting.

5 W 1346mm SETUP SHEET ROLL Press **MENU**. Press **◀** to go back to the original screen.

### Description

Depending on the media, media may wrinkle or come loose from the platen during outputting, increasing the chance of contact with the print heads. When you are using such media, adjust the head height to "HIGH". Note that the height of the heads cannot be determined by just the thickness of the media.

Misalignment may occur during bidirectional printing due to the head height or the thickness of the media. If this happens, perform bidirectional correction to match the media you're using.

☞ P.100 "Correcting for Misalignment in Bidirectional Printing", P.101 "Correcting for Misalignment in Bidirectional Printing More Precisely"



### Default Setting





[HEAD HEIGHT]: Low



## Using Transparent Media

### Procedure

- 1 MENU ▾  
SUB MENU ▶

Press  .  
Press  several times .
- 2 EDGE DETECTION ◀▶  
ENABLE ▶ DISABLE ◀

Press  .  
Use   to select "DISABLE".  
Press  to enable the setting.
- 3 W 1346mm  
SETUP SHEET  
◀▶ ROLL

Press  .  
Press  to go back to the original screen.

### Description

This setting enables or disables detection of the leading and trailing edges of the media. It is normally set to "ENABLE." When transparent media is loaded, set it to "DISABLE." When this is set to "DISABLE", the "ROLL" and "TU" selections are available during media setup. At this time, ensure a margin of at least 75 mm from the leading edge of the media to the printing- or cutting-start location.

When [EDGE DETECTION] is set to "DISABLE", the machine cannot detect when media runs out. In such cases, printing operation does not stop when the media runs out, and there is a chance that the platen or the like may become soiled by ink or that ink may get inside and damage the machine. If media runs out while printing is in progress, immediately press  to quit printing.



### Default Setting



[EDGE DETECTION]: ENABLE





## Printing Hard-to-dry Media



### Procedure

- 1 MENU ▾  
SUB MENU ▶

Press  .  
Press  several times.
- 2 SUB MENU ◀▶  
SCAN INTERVAL ▶

Press  .  
Press  .
- 3 SCAN INTERVAL ◀▶  
OFF ▶ 1. 0 sec ◀

Press  .  
Use   to set the value.  
Press  .
- 4 W 1346mm  
SETUP SHEET  
◀▶ ROLL

Press  .  
Press  to back to original screen.



---

### Description

---

You use this when ink dries poorly even when the print heater and dryer are used. Larger values produce progressively slower movement of the media, enabling you to extend the drying time accordingly. Printing time takes correspondingly longer.

You can also make this setting on the computer. When you have made the setting on the computer, the computer's setting is used and the printer's setting is ignored.

---

### Default Setting

---













[SCAN INTERVAL]: OFF

## Preventing Media from Coming Loose

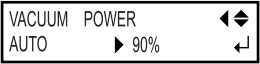
---

### Procedure

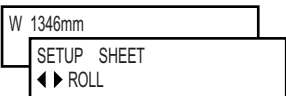
---

- 1**  Press .  
Press  several times.
- 2**  Press .  
Use  twice.
- 3**  Press .  
Use  and  to set the value.  
Press  to enable the setting.
- 4**  Press .  
Press  to go back to the original screen.

---

### Description

---

The platen uses suction to grip the media and keep it stable. When media comes loose from the platen because it is warped or wrinkled, increasing the suction force may help correct the problem. Conversely, when the media is flimsy and cannot move smoothly, reducing the suction force may help.

When set to "AUTO", the suction force is automatically adjusted to the optimal level for the media width.

You can also make this setting on the computer. When you have made the setting on the computer, the computer's setting is used and the printer's setting is ignored.

---













### Default Setting

---

[VACUUM POWER]: AUTO

## Speeding Up Output for Narrow Media

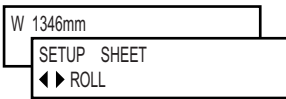
### Procedure

- 1  Press .  
Press  several times.
- 2  Press .  
Press  several times.
- 3  Press .  
Use   to select "SHEET" or "OFF".  
Press  to enable the setting.
- 4  Press .  
Press  to go back to the original screen.

### Description

This shortens output time by reducing the width of head movement to the minimum necessary. This is effective when the width of the media or the output data is narrow.

"SHEET" matches the range of head movement to the width of the media.

"OFF" matches the range of head movement to the output data. Movement is limited to the minimum amount necessary, and this can be expected to yield the fastest output. Note, however, that because the speed of media movement is no longer constant, colors may be uneven.









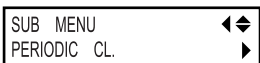

"FULL" makes the speed of media movement constant at all times.

### Default Setting

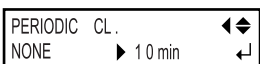
[FULL WIDTH S]: FULL

## Keeping Media from Being Soiled by Ink Drops

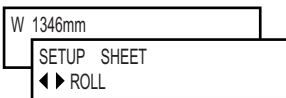
### Procedure

- 1  Press .  
Press  several times.
- 2  Press .  
Press  several times.
- 3  Press .  
Use   to select a value from "10 min" to "990 min," or "PAGE."  
Press  to enable the setting.
- 4  Press .  
Press  to go back to the original screen.

---

### Description

---

Ink tends to collect on the surface of the heads when you use media prone to build up a static charge, or when the ambient temperature is low. Under some conditions, this ink may be transferred to the media. Use this feature at such times. The ink buildup is removed as printing is performed.

When this is set to "PAGE", automatic cleaning is performed every time before printing starts.

When this is set to a value from "10min" to "990min", automatic cleaning is performed when the cumulative printing time reaches the value you set here.

When this is set to "NONE", no automatic cleaning is performed.

Using "PAGE" or a value from "10min" to "990min", results in longer printing times. Also, when this is set to a value from "10min" to "990min", printing pauses and so colors may be uneven.

---

### Default Setting

---

[PERIODIC CL.]: NONE

## How to Load Sheet Media

As with standard-size media, make sure of the following points when loading sheet media.

### Procedure

- 1 Remove both shafts.

If roll media is loaded, then remove the media first.

- 2

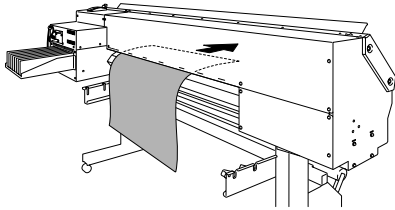

Pass the media through the machine.

- 3

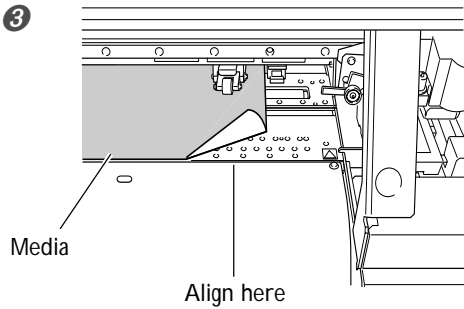

Align the front edge of the media with the location shown in the figure.

- 4 Lower the loading lever to secure the media in place.

- 5 If you're performing outputting, attach the media clamps and close the front cover.

- 6

















Use ◀ ▶ to select "PIECE" .  
Press ENTER .

# 6-5 Setting How the Printer Operates

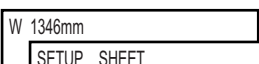
## Determining What Happens When an Ink Cartridge Is Empty

### Procedure

-  Press .  
Press  several times.
-  Press .  
Press  twice.
-  Press  twice.  
Use   to make the setting.  
Press  to enable the setting.
-   
 Press .  
Press  to go back to the original screen.

### Description











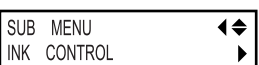

This lets you change, according to your purpose, the operation that takes place when an ink cartridge is empty. "STOP" immediately pauses operation when a cartridge becomes empty. Because pausing printing in progress may make colors uneven, it is best to ensure a sufficient amount of remaining ink before you begin printing. "CONT." (continue) is a mode in which operation is not automatically stopped. When a cartridge becomes empty, a warning beep sounds but printing doesn't stop. To replace the cartridge, you must either wait until printing ends or press the  to pause printing. Note that operation does not stop even if ink runs out completely.

### Default Setting

[EMPTY MODE]: STOP

## Changing the Type of Ink

### Procedure













-  Press .  
Press  several times.
-  Press .  
Press  twice.
-  Press .  
Press .
-  Press .  
Use   to make the setting.  
Press  to execute the setting.

### Description

You use this when changing the type of ink. Selecting the type of ink used for replacement starts head-cleaning and ink-filling operations. Follow the on-screen instructions to insert and remove cartridges. This operation requires four unused cleaning cartridge.

## Setting the Interval until Activation of the Sleep Mode

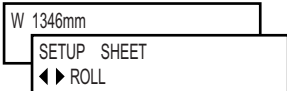
### Procedure











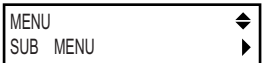



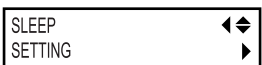

- 1**  Press .  
Press  several times.
- 2**  Press .  
Press  several times.
- 3**  Press  twice.  
Use   to make the setting.  
Press  to enable the setting.
- 4**  Press .  
Press  to go back to the original screen.

### Default Setting

[INTERVAL]: 30min

## Deactivating the Sleep Mode

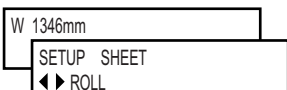
### Procedure

- 1**  Press .  
Press  several times.
- 2**  Press .  
Press  several times.
- 3**  Press .  
Press .
- 4**  Press .  
Use   to select "DISABLE".  
Press  to enable the setting.
- 5**  Press .  
Press  to go back to the original screen.

### Default Setting

[SETTING]: ENABLE

## Preventing Pulling of the Media with Undue Force When Performing Cutting Only

### Procedure

- 1

MENU	◀▶
CUTTING MENU	▶

Press .  
Press .
- 2

CUTTING MENU	◀▶
PREFEED	▶

Press .  
Press several times.
- 3

PREFEED	◀▶
DISABLE	▶ ENABLE ◀

Press .  
Use to select "DISABLE".  
Press to enable the setting.
- 4

W 1346mm	◀▶
SETUP SHEET	▶
◀▶ ROLL	▶

Press .  
Press to go back to the original screen.

### Description

When you're performing cutting only, it may be convenient to set this feature to "ENABLE." This feeds out media according to the size of the data sent from the computer before performing cutting. This makes it unnecessary to turn the media flanges by hand to feed out media every time you perform cutting. Note, however, that this feeds out media even when you're performing printing only, so set it to "DISABLE" when not needed.

### Default Setting

[PREFEED]: DISABLE

## Drying the Trailing Edge of the Printing Area on the Dryer

### Procedure

- 1

HEATER MENU	◀▶
FEED FOR DRY	▶

Hold down and press .
- 2

FEED FOR DRY	◀▶
DISABLE	▶ ENABLE ◀

Press .  
Use to select "ENABLE".  
Press to enable the setting.
- 3

W 1346mm	◀▶
SETUP SHEET	▶
◀▶ ROLL	▶

Press .  
Press to go back to the original screen.

### Description

When this menu item is set to "ENABLE", additional media feed is performed until the trailing edge of the printing area is positioned directly on the dryer. The margin between the print-end position and the next print-start position is fixed at 200 mm. Any margin setting made on the computer is ignored.













When this is set to "DISABLE", media feed stops simultaneously when printing ends. This means that the trailing edge of the printing area is not fed to the dryer unless you continue with a subsequent printing operation.

### Default Setting

[FEED FOR DRY]: DISABLE

## Giving Priority to Image Quality

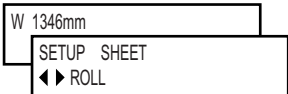
### Procedure

- 1  Press .  
Press  several times.
- 2  Press .  
Press  several times.
- 3  Press .  
Use   to select "DISABLE".  
Press  to enable the setting.
- 4  Press .  
Press  to go back to the original screen.

### Description











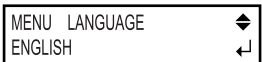

This setting determines whether priority is given to efficient ink use or to image quality. It is displayed only when four-color inks are used (cyan, magenta, yellow, and black). This setting is valid only when using four-color inks and performing bidirectional printing. Also, some high-speed print modes may not be affected by this setting. When set to "ENABLE", ink is used more efficiently, with nearly no sacrifice in image quality. When set to "DISABLE", priority is given to image quality over efficient use of ink.

### Default Setting

[ALTERNATE HEAD]: ENABLE

## Changing the Menu Language and the Units of Measurement

### Procedure

- 1  Hold down  and switch on the sub power.  
Use   to select the display (menu) language.  
Press .
- 2  Use   to select the measurement unit for length.  
Press .
- 3  Use   to select to the measurement unit for temperature.  
Press .

### Description

This sets the language and units of measurement displayed on the printer's screen.

### Default Setting

[MENU LANGUAGE]: ENGLISH













[LENGTH UNIT]: mm

[TEMP. UNIT]: °C

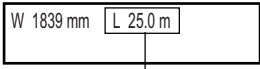

## Displaying the Amount of Remaining Media on the Printer's Screen

### Procedure

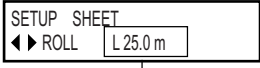
- 1  Press .  
Press  twice.
- 2  Press .  
Press .
- 3  Press .  
Use  and  to set the amount of media remaining.  
Press  to enable the setting.
- 4  Press .  
Press  to go back to the original screen.  
  
  
This display is updated.  
  
If setup has not been performed, the set value flashes.

### Description

You can display how much of the media in use is left. Once you set the amount of media remaining, the amount remaining is displayed at the top menu until it reaches zero. If you cancel the setup such as by removing the media or raising the loading lever, the amount remaining at that time flashes on the screen.

The amount of media remaining is not updated automatically when you change the media. Redo the setting whenever you change the media.













Note, however, that when sheet media is loaded (that is, when [SHEET SELECT] is set to "PIECE"), the setting for the amount of remaining media is made automatically.

You can also make the setting to display this menu automatically whenever you change the media. See the next section "Verifying the Setting for the Amount Remaining Every Time the Media Is Changed."

\*The remaining amount that is displayed is only an estimate, and its accuracy is not assured.

## Verifying the Setting for the Amount Remaining Every Time the Media Is Changed

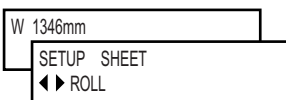
### Procedure

- 1  Press .  
Press  twice.
- 2  Press .  
Press  twice.
- 3  Press .  
Use  and  to select "ENABLE".  
Press  to enable the setting.
- 4  Press .  
Press  to go back to the original screen.

---

**Description**

---

Setting this to "ENABLE" automatically displays [SHEET REMAIN] whenever you change the media and finish setup. This makes it impossible to go on to the next operation unless you redo the setting for the amount remaining. This can be useful for keeping you from forgetting to redo the setting when you change the media.

When you set this to "ENABLE", however, be sure also to set the [EDGE DETECTION] menu item to "ENABLE". When [EDGE DETECTION] is set to "DISABLE", then [SHEET REMAIN] is not displayed automatically, regardless of the setting for [AUTO DISPLAY].

Also, when sheet media is loaded (that is, when [SHEET SELECT] is set to "PIECE"), the setting for the amount of remaining media is made automatically, and so this menu is not displayed.

☞ P.86 "Using Transparent Media"

---

**Default Setting**

---









[AUTO DISPLAY]: DISABLE

## Printing the Amount of Remaining Media

---

**Procedure**

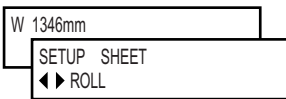
---

- 1  Press .  
Press  twice.
- 2  Press .  
Press  to perform printing.
- 3  Press .  
Press  to go back to the original screen.

---

**Description**

---







This prints the amount of media remaining that is displayed at the top menu. You use this when you want to make a record of the remaining length of the media now in use. Printing the amount of media remaining before you change the media enables you to refer to the printed record and use the value to make the setting for the remaining amount the next time you use the media.

## Returning All Settings to Their Initial Values

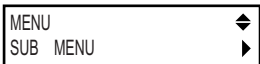
---

**Procedure**

---

- 1  Press .  
Press  several times.
- 2  Press .  
Press  several times.  
Press  to execute.

---

**Description**























---

This menu returns all settings to the same as their factory defaults. However, the settings for [LANGUAGE], and [LENGTH UNIT], [NETWORK] are not returned to the factory defaults.

# 6-6 Making Various Adjustments for Cutting

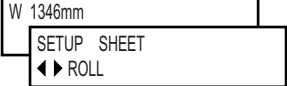
## Performing Distance Correction During Cutting

### Procedure

- 1**  Press .  
Press .
- 2**  Press .  
Press  twice.
- 3**  Press  twice.  
Use   to make the setting for the correction value.  
Press  to enable the setting for "FEED SETTING".
- 4**  Press .  
Press .
- 5**  Press .  
Use   to make the setting for the correction value.  
Press  to enable the setting for "SCAN SETTING".
- 6**  Press .  
Press  to go back to the original screen.

### Description

The movement distance for the media changes subtly depending on the media's thickness. This means that the length of a line when cut may differ from the length setting in the data. You enter a correction value when you want to align the lengths of cut lines precisely.

When performing printing followed immediately by cutting, be sure to set this to "0.00".









### Default Setting

[FEED SETTING]: 0.00%

[SCAN SETTING]: 0.00%

## Fine-tuning the Cutting Conditions

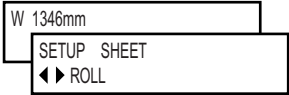
### Procedure

- 1  Press .  
Use   to choose the cutting condition you want to set.  
Use   to enter the value.
- 2  Press  to enable the setting and go back to the original screen.

### Description

This enables you to check and verify the settings for the cutting conditions using cutting-test results.

☞ P.47 "Performing a Cutting Test"

[FORCE]: This sets the force (pressure) of the blade.

[SPEED]: This sets the speed of cutting.

[OFFSET]: This makes the blade-offset setting for the blade. Enter the listed offset value for the blade. (The offset value for the included blade is 0.25 mm.)

[UP-SPEED]: This sets the blade's up speed during cutting (the speed at which the blade travels when it moves to the next cutting line after cutting one cutting line). If the media comes loose during no-load feed and the blade damages the surface of the media, reduce the speed.

### Evaluating the Results of a Cutting Test

- 1 Check the shape of the test pattern.

The cut shape is distorted.

Reduce the cutting speed.

- 2 Peel off circle 1.

Rectangle 2 also peels off.

Increase the blade force.

Some uncut areas remain.

Reduce the cutting speed.

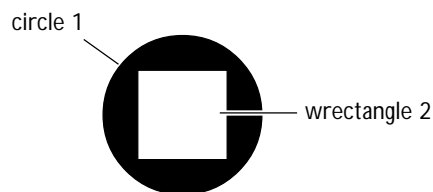

- 3 Peel off rectangle 2.

The blade should leave faint traces on the backing paper.

The blade trace is indistinct.

Increase the blade force.

The blade trace is too deep and cuts into the backing paper.

Reduce the blade force.

- 4 Check the shape of rectangle 2.

A. Good

B. The corners are rounded.

Increase the amount of blade offset.

C. The corners have "horns."

Reduce the amount of blade offset.

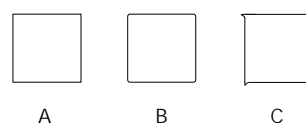

## Accurately Adjusting the Cutting-in Amount

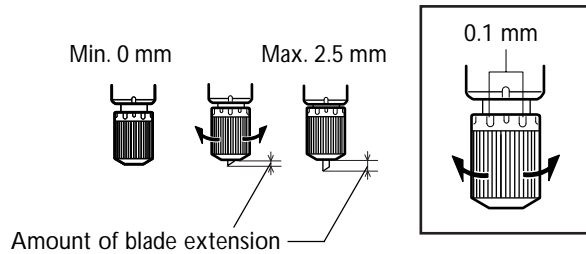

When you want to perform accurate and fine adjustment of the cutting-in amount, such as when cutting media with thin carrier paper, you can obtain good results by adjusting the tip of the blade.

Turn the cap portion of the blade holder to adjust the amount of blade extension. Each indicator tick corresponds to 0.1 mm, and adjustment for 0.5 mm can be made by rotating the cap one full turn.

Note that making the amount of blade extension too small may cause the end of the cap for the blade holder to touch and damage the printed surface. It's important to be especially careful about this when you're using media that has poor ink-adhesion properties.

### Rough Estimate for the Amount of Blade Extension

Use the following dimension as a rough estimate for setting the amount of blade extension.

$$\text{Amount of blade extension} = \text{Thickness of the media portion} + \frac{\text{Thickness of the carrier paper}}{2}$$

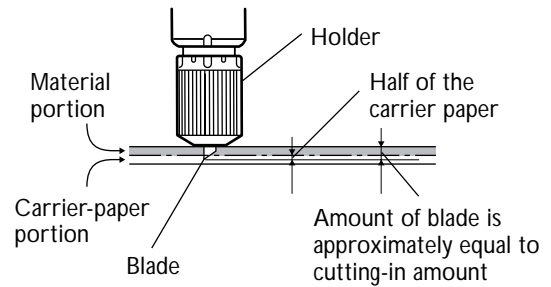

## Making the Cutting Conditions Set on the Machine Take Precedence

### Procedure

- 1

MENU	◀▶
CUTTING MENU	▶

Press .  
Press .
- 2

CUTTING MENU	◀▶
CUTTING PRIOR	▶

Press .  
Press twice.
- 3

CUTTING PRIOR	◀▶
COMMAND	▶ MENU

Press .  
Use to select [MENU.]  
Press to enable the setting.
- 4

W 1346mm
SETUP SHEET
◀▶ ROLL

Press .  
Press to go back to the original screen.

### Description







You can also make the settings for the cutting conditions using the computer. By default, the settings made with the computer take priority. To make the cutting conditions set on the machine take priority, either turn off the settings of the computer or make the setting described above.

# 6-7 Correcting Misalignment for Printing or Cutting

## Correcting for Misalignment in Bidirectional Printing

### Procedure





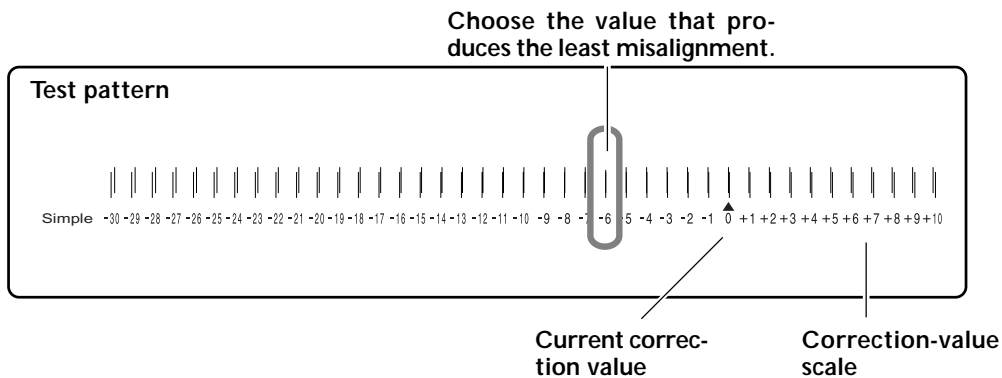

#### 1. Print a test pattern.

-  Press .  
Press .
-  Press .  
Press  to start printing.



#### 2. Read the correction values from the test pattern.



#### 3. Enter the correction values that you read.

-  Press .
-  Press .  
Use   to set the correction values.  
Press  to enable the setting.

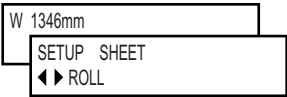
#### 4. Go back to the original screen.

- 
- Press .
- Press  to go back to the original screen.

**Description**

The bidirectional-printing mode (in which the heads perform printing during both their outbound pass and return pass) offers the advantage of being able to shorten output times, but subtle misalignment occurs during the outbound and return passes. The procedure to correct this and eliminate misalignment is bidirectional correction. This misalignment varies according to the head height and the thickness of the media, so we recommend performing correction to match the media you're using.

This setting also serves to correct for misalignment when you're performing printing followed immediately by cutting, or when you're performing printing and cutting using crop marks. In such cases, check or adjust this setting.

☞ P.104 "Correcting Misalignment of the Printing and Cutting Positions During Printing Followed Immediately by Cutting", P.107 "Correcting Misalignment for Printing and Cutting When Using Crop Marks"

**Correcting for Misalignment in Bidirectional Printing More Precisely**

**Procedure**

**1. Print a test pattern.**

- |                                                                                                                                                                      |                                                  |
|----------------------------------------------------------------------------------------------------------------------------------------------------------------------|--------------------------------------------------|
| <p><b>1</b></p> <div style="border: 1px solid black; padding: 2px; display: inline-block;">             MENU<br/>             ADJUST BI-DIR         </div>           | <p>Press  .</p> <p>Press  .</p>                  |
| <p><b>2</b></p> <div style="border: 1px solid black; padding: 2px; display: inline-block;">             ADJUST BI-DIR<br/>             DETAIL SETTING         </div> | <p>Press  .</p> <p>Press  .</p>                  |
| <p><b>3</b></p> <div style="border: 1px solid black; padding: 2px; display: inline-block;">             DETAIL SETING<br/>             TEST PRINT         </div>     | <p>Press  .</p> <p>Press  to start printing.</p> |

**2. Read the correction values from the test pattern.**

**Test pattern**

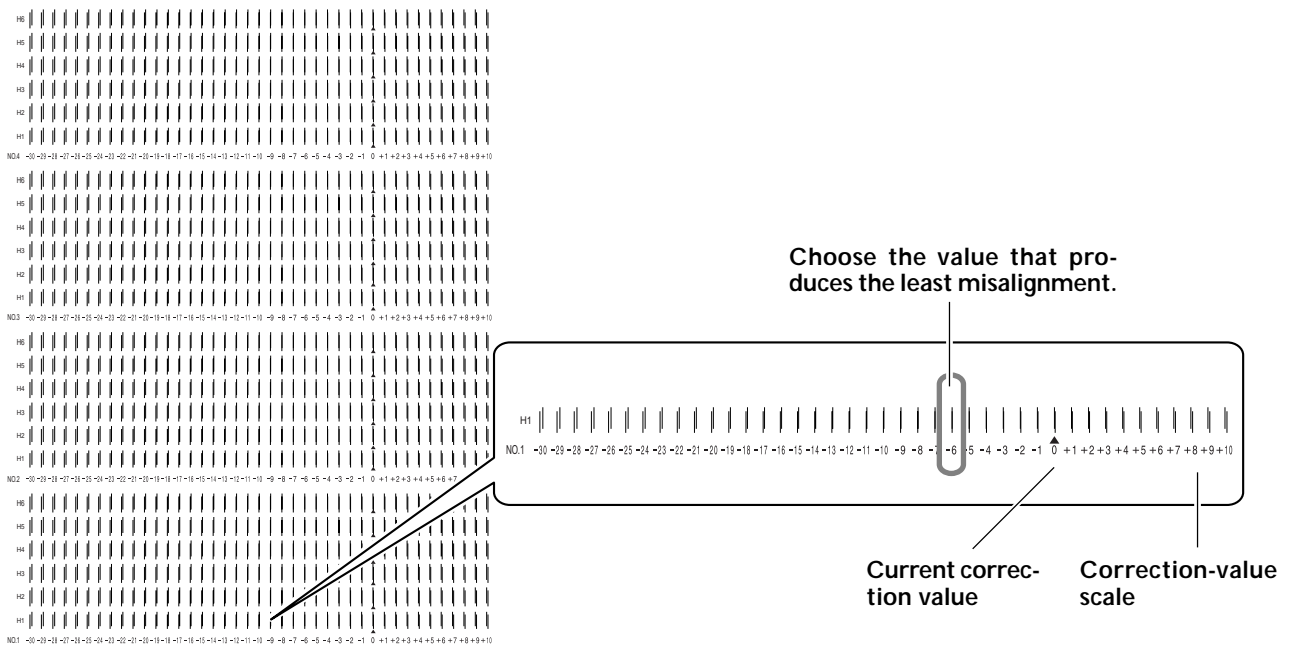

### 3. Enter the correction values that you read.

Enter the corresponding correction values for H1 through H6.

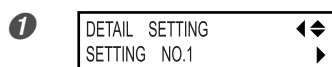

Press .

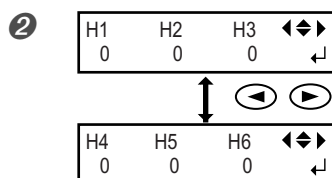

Press .  
Use to select. Use to set the correction values.  
Press for finish making the settings for SETTING NO.1.

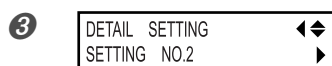

Press .

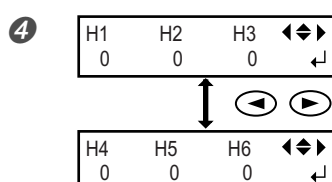

Press .  
Use to select. Use to set the correction values.  
Press for finish making the settings for SETTING NO.2.

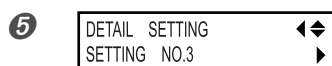

Press .

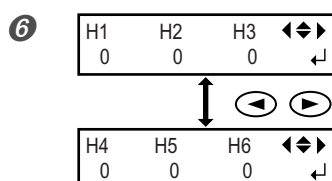

Press .  
Use to select. Use to set the correction values.  
Press for finish making the settings for SETTING NO.3.

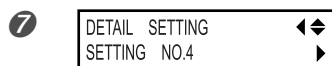

Press .

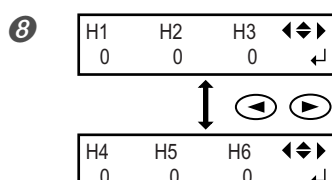

Press .  
Use to select. Use to set the correction values.  
Press for finish making the settings for SETTING NO.4.

### 4. Go back to the original screen.

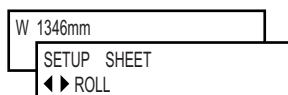

Press .

Press to go back to the original screen.

#### Description







This corrects, for each head, the minute misalignment that occurs in the bidirectional-printing mode. When further correction is required, such as when adjustment made using [SIMPLE SETTING] do not enhance printing, use [DETAIL SETTING] to make corrections for each head.



## Performing Feed Correction to Alleviate Horizontal Bands and the Like

### Procedure





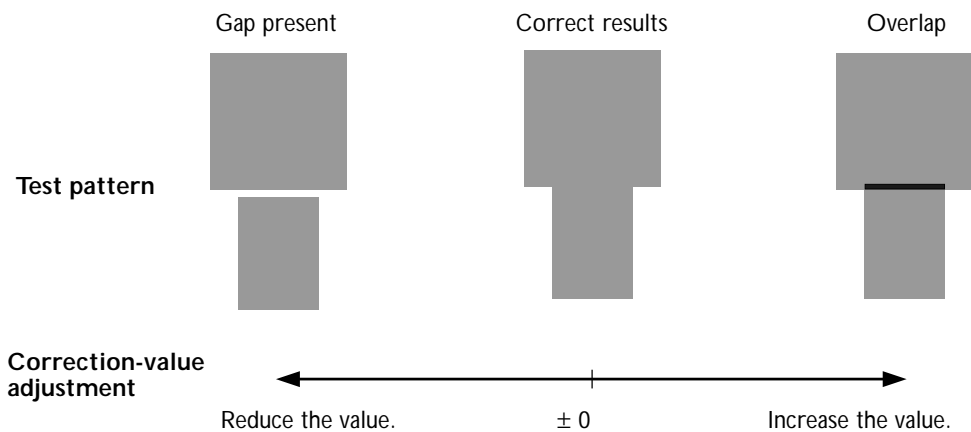

#### 1. Print a test pattern.

- ①  Press .  
Press  several times.
- ②  Press .  
Press  to start printing.



#### 2. Check the test pattern you printed.



#### 3. Enter the correction value.

-  Press .  
Press .  
Use   to make the setting for the correction value.  
Press  to enable the setting.

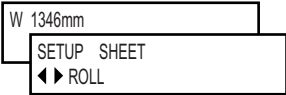
#### 4. Go back to the original screen.

-  Press .  
Press  to go back to the original screen.

---

### Description

---

The movement transfer of media experiences subtle changes due to the thickness of the media and the temperature of the heating devices. When the movement distance becomes discrepant, horizontal stripes are more likely to occur during printing. We recommend performing correction to match the media you're using and the heating devices. Repeat the process of printing a test pattern and entering a correction value a number of times to find the optimize value.

After correction, performing take-up to return the media and carrying out printing may not produce correct results. When resetting the page spacing after correction, set it to a value of 40 millimeters or more.

Printing this test pattern using parameters identical to those for actual printing. Also, using material such as media scraps that have passed through the printer may not yield correct results.

Note, however, that you can also make this setting on the computer (by, for example, choosing the media type in the RIP program you are using). Use this feature when you want to make the setting on the printer, without changing any settings on the computer. When you've made the setting on the computer, the computer's setting takes precedence and the printer's setting is ignored.

---

### Default Setting

---

[SETTING]: 0.00%

---

## Correcting Misalignment of the Printing and Cutting Positions During Printing Followed Immediately by Cutting

---

---

### Procedure

---

#### **1.** Check the setting for the [AUTO ENV.MATCH] menu item.

---

Make sure the [AUTO ENV. MATCH] menu item is set to "ENABLE."

☞ P84. "Making the Setting for Automatic Adjustment of the Printer to the Operating Environment"

#### **2.** Execute the [ADJUST BI-DIR] menu item.

---

##### **1** Load the media.

☞ P.30 "How to Load Media"









☞ P.90 "How to Load Sheet Media"

##### **2** Perform bidirectional adjustment.

☞ P.100 "Correcting for Misalignment in Bidirectional Printing"

☞ P.101 "Correcting for Misalignment in Bidirectional Printing More Precisely"

### 3. Print a test pattern and cut it.

- 1  Press .  
Press .
- 2  Press .
- 3  Press .  
Press .

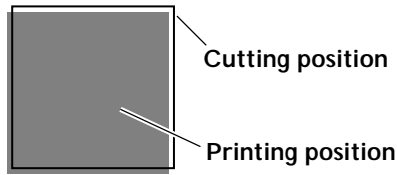

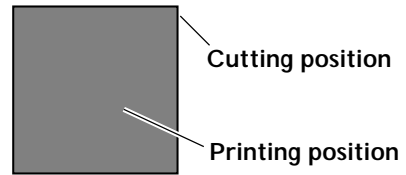

Cutting position and printing position are misaligned



Cutting position and printing position are aligned

When adjustment is needed, go on to the steps below.







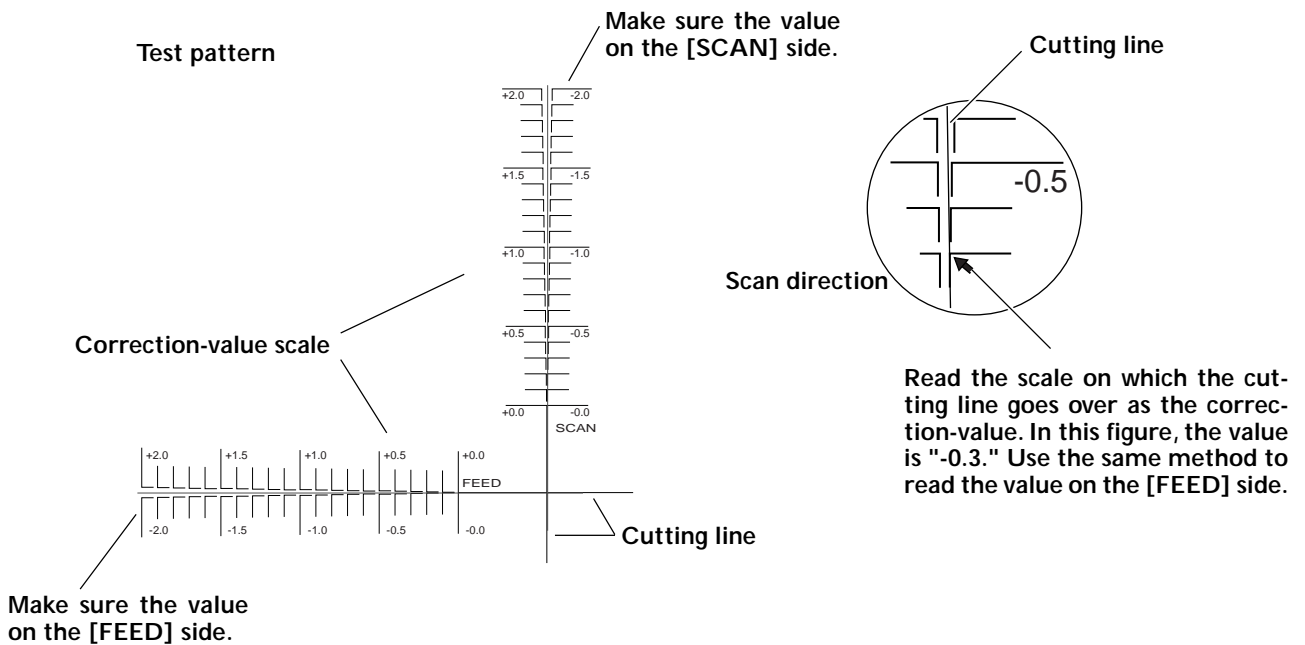



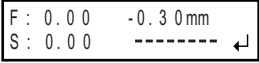

### 4. Print a test pattern and cut it.

- 
- Press
- 
- .
- 
- Press
- 
- to execute.

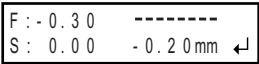

### 5. From the test pattern, read the value at the location.

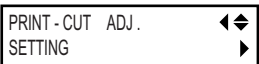

## 6. Enter the adjustment value you read.

- 1  Press .
- 2  Press   
 Use   to make the setting for the correction value.  
 Press  to enable the setting for FEED SETTING.
- 3  Use   to make the setting for the correction value.  
 Press  to enable the setting for SCAN SETTING.
- 4  Press .

## 7. Check the results of adjustment.

-  Press   
 Press  to execute.  
 If the printing and cutting lines are aligned, adjustment is complete.

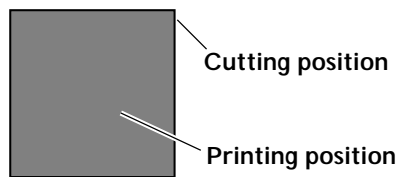

Cutting position and printing position are aligned

### Description

You perform this when printing followed immediately by cutting yields positioning for printing and cutting that is slightly misaligned. You print alignment marks, perform detection of the printed marks, and correct the discrepancy. Subtle misalignment between the printing and cutting positions may occur due to the thickness of the media or the head height. We recommend making correction to match the media you're using.

### Default Setting

[FEED SETTING]: 0.0 mm  
 [SCAN SETTING]: 0.0 mm

## Correcting Misalignment for Printing and Cutting When Using Crop Marks

### Procedure

#### 1. Check the setting for the [AUTO ENV. MATCH] menu item.

Make sure the [AUTO ENV. MATCH] menu item is set to "ENABLE."

☞ P.84 "Making the Setting for Automatic Adjustment of the Printer to the Operating Environment"

#### 2. Execute the [ADJUST BI-DIR] menu item.

##### 1 Load the media.

☞ P.30 "How to Load Media"







☞ P.90 "How to Load Sheet Media"

##### 2 Perform bidirectional adjustment.

☞ P.100 "Correcting for Misalignment in Bidirectional Printing"

☞ P.101 "Correcting for Misalignment in Bidirectional Printing More Precisely"

#### 3. Print a test pattern and cut it.

- |   |                               |                                                                                                                                                                                        |
|---|-------------------------------|----------------------------------------------------------------------------------------------------------------------------------------------------------------------------------------|
| 1 | MENU<br>CUTTING MENU          | Press <br>Press  |
| 2 | CUTTING MENU<br>CROP-CUT ADJ. | Press <br>Press  |
| 3 | CROP-CUT ADJ.<br>TEST PRINT   | Press <br>Press  |

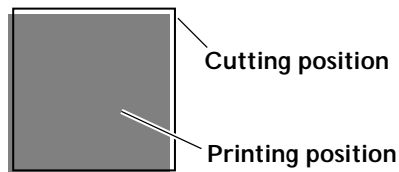

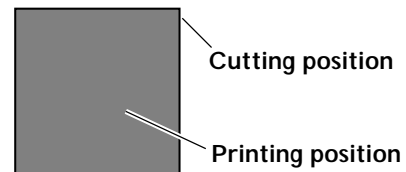

Cutting position and printing position are misaligned



Cutting position and printing position are aligned

When adjustment is needed, go on to the steps below.

#### 4. Print a test pattern and cut it.

- |                               |                                                                                                                                                                                                           |
|-------------------------------|-----------------------------------------------------------------------------------------------------------------------------------------------------------------------------------------------------------|
| CROP-CUT ADJ.<br>TEST PRINT 2 | Press  twice.<br>Press  to execute. |
|-------------------------------|-----------------------------------------------------------------------------------------------------------------------------------------------------------------------------------------------------------|

### 5. From the test pattern, read the adjustment value at the location.

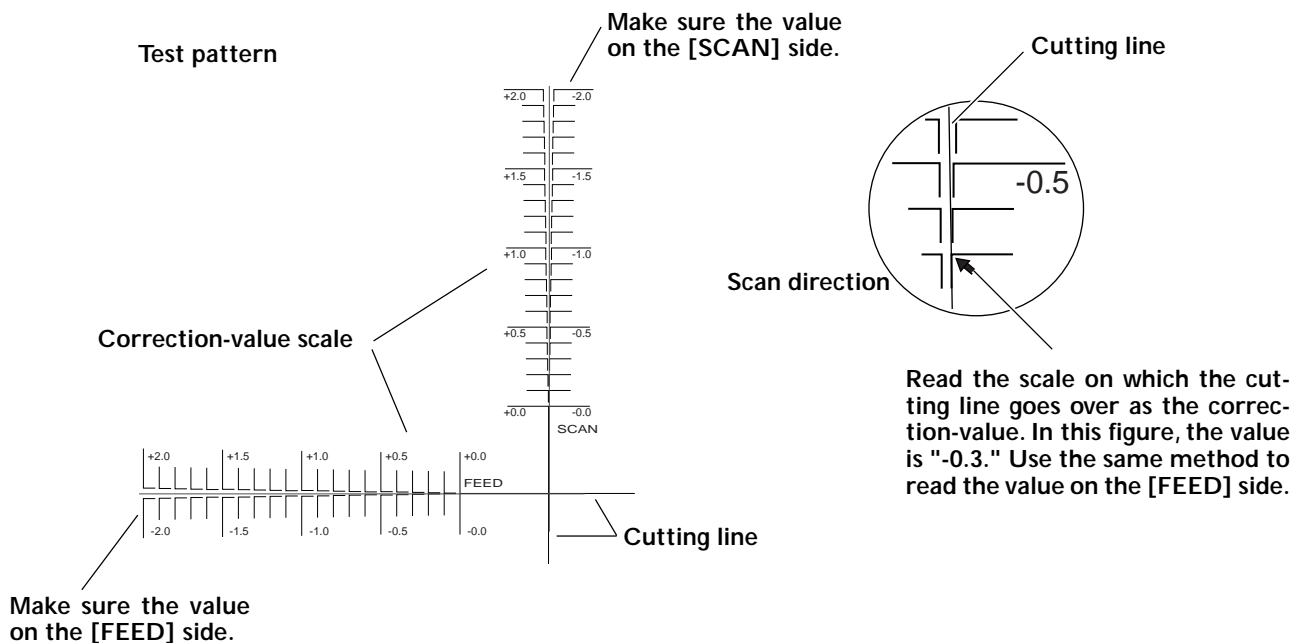

### 6. Enter the adjustment value you read.

1. 

CROP-CUT ADJ. SETTING	↕
--------------------------	---

 Press .  
Press .
2. 

F : 0.00	-0.30mm	↕
S : 0.00	-----	↕

 Use to make the setting for the correction value.  
Press to enable the setting for FEED SETTING.
3. 

F : -0.30	-----	↕
S : 0.00	-0.20mm	↕

 Use to make the setting for the correction value.  
Press to enable the setting for SCAN SETTING.
4. 

CROP-CUT ADJ. SETTING	↕
--------------------------	---

 Press .

### 7. Check the results of adjustment.

- |                             |   |
|-----------------------------|---|
| CROP-CUT ADJ.<br>TEST PRINT | ↕ |
|-----------------------------|---|
- Press .
- Press to execute.
- If the printing and cutting lines are aligned, adjustment is complete.

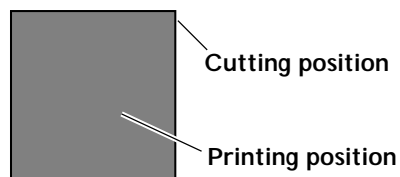

Cutting position and printing position are aligned

---

### Description

---

Depending on the composition of the media, the positioning of printing and cutting may be misaligned even when you're using crop marks. Make corrections for misaligned printing and cutting for the media you're using.

---

### Default Setting









---

[FEED SETTING]: 0.0 mm  
[SCAN SETTING]: 0.0 mm

# 6-8 Setting How the Media Heating System Operates

## Switching Off the Preheater, Print Heater, or Dryer

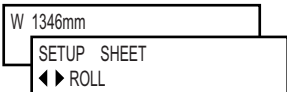
### Procedure

-  Press  twice.  
Use   to select the device.  
Press  several times to select [OFF].  
Press  to enable the setting.
-  Press .  
Press  to go back to the original screen.

### Description

This makes the temperature settings for the media heating system (preheater, print heater, and dryer), as well as switching these devices on or off. When this is set to [OFF], these devices do not operate at all.

You can also make this setting on the computer. When you've made the setting on the computer, the computer's setting takes precedence and the printer's setting is ignored.





### Default Setting

[PRE] (preheater): 35°C (95°F)  
[PRINT] (print heater): 40°C (95°F)  
[DRYER]: 50°C (122°F)



## Determining How the Media Heating System Operates

### Procedure

- 1**  Hold down **MENU** and press **HEATER CONFIG**.
- 2**  Press **▼**.
- 3**  Press **▶**.  
Use **▲** and **▼** to make the setting.  
Press **ENTER** to enable the setting.
- 4**  Press **MENU**.  
Press **◀** to go back to the original screen.

### Description

This feature controls the temperature of the media heating system automatically when **SET UP** is dark.

[MENU] performs heating to the preset temperature at all times, without lowering the temperature when the **SET UP** is dark.

[30°C] lowers the media heating system to a fixed temperature (30°C) when **SET UP** is dark.

[OFF] switches off the media heating system when **SET UP** is dark.



### Default Setting

[PREHEATING]: 30°C

# 6-9 Setting How the Auxiliary Dryer Operates

## Switching the Drying-heater Unit On and Off

### Procedure

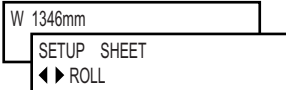
-  Hold down **MENU** and press **HEATER CONFIG**.  
Press **▼** twice.
-  Press **▶**.  
Use **▲** **▼** to select "ENABLE" or "DISABLE".  
Press **ENTER**.
-  Press **MENU**.  
Press **◀** to go back to the original screen.

### Description

This switches the optional drying-heater unit on or off.

The machine settings govern the temperature setting for the drying-heater unit, so when installation is complete, set [OPTIONAL DRYER] on the machine to "ENABLE."

### Default Setting

[OPTIONAL DRYER]: DISABLE

## Switching the Optional Blower-fan Unit On and Off

### Procedure

- 1**



Hold down **MENU** and press **HEATER CONFIG**.  
Press **▼**.
- 2**



Press **▶**.  
Use **▲** **▼** to select "ENABLE" or "DISABLE".  
Press **ENTER**.
- 3**

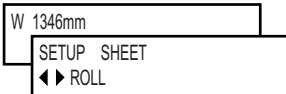

Press **MENU**.  
Press **◀** to go back to the original screen.

### Description

This switches the blower-fan unit on or off.  
When the blower-fan unit is installed, set [BLOWER FAN] to "ENABLE."













### Default Setting

[BLOWER FAN]: DISABLE

# 6-10 Saving the Printer Settings to Match the Media

## Saving Optimized Media Settings As Preset Values

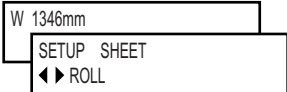
### Procedure

- 1**  Press .
- 2**  Press .  
Press .
- 3**  Press .  
Use   to select any one from "NAME1" to "NAME8".  
Press  to save.  
The present menu settings are saved in the preset you chose in step **3**.
- 4**  Press .  
Press  to go back to the original screen.

### Description

Using the [PRESET] menu lets you easily change a wide variety of settings to optimize them for the media. Making changes for each menu item every time you change the media can be troublesome. That's why it can be useful to save the menu-item settings optimized for an often-used type of media as a preset. The next time you use the media, you can change the menu-item settings to the optimal values for the media simply by loading the preset you saved. Menu Items That can be saved in presets shown on the next page.

---

**Menu Items That Can Be Saved in Presets**

---

[PRE] (Pre heater)

[PRINT] (Print heater)

[DRYER]

☞ P.36 "Settings of the Media Heating System"

[EDGE DETECTION]

☞ P.86 "Using Transparent Media"

[SCAN INTERVAL]

☞ P.86 "Printing Hard-to-dry Media"

[VACUUM POWER]

☞ P.87 "Preventing Media from Coming Loose"

[FULL WIDTH S]

☞ P.88 "Speeding Up Output for Narrow Media"

[FEED FOR DRY]

☞ P.93 "Drying the Trailing Edge of the Printing Area on the Dryer"

[ALTERNATE HEAD]

☞ P.94 "Giving Priority to Image Quality"

[CALIBRATION]

(in the CUTTING MENU)

☞ P.97 "Performing Distance Correction During Cutting"

[FORCE]

[SPEED]

[OFFSET]

[UP-SPEED]

☞ P.98 "Fine-tuning the Cutting Conditions"

[ADJUST BI-DIR SIMPLE SETTING]

☞ P.100 "Correcting for Misalignment in Bidirectional Printing"

[ADJUST BI-DIR DETAIL SETTING]

☞ P.101 "Correcting for Misalignment in Bidirectional Printing More Precisely"

[CALIBRATION]

☞ P.103 "Performing Feed Correction to Alleviate Horizontal Bands and the Like"

[PRINT-CUT ADJ.]

☞ P.104 "Correcting Misalignment of the Printing and Cutting Positions During Printing Followed Immediately by Cutting"

[CROP-CUT ADJ.]

☞ P.107 "Correcting Misalignment for Printing and Cutting When Using Crop Marks"

[PREHEATING]

☞ P.111 "Determining How the Media Heating System Operates"

[BLOWER FAN]









☞ P.113 "Switching the Optional Blower-fan Unit On and Off"

Up to eight types of preset can be saved. You can assign a name to each ones so that using media names may aid recognition and clarity.

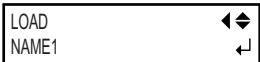
☞ P.116 "Loading a Saved Preset", P.116 "Assigning a Name to a Preset"



## Loading a Saved Preset

### Procedure

- 1  Press .
- 2  Press  twice.  
Use   to select the name of a preset you want to load.
- 3  Press  to load.  
The settings are changed and the screen shown in the figure appears.











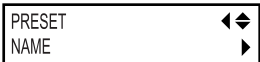







### Description

This loads a saved preset. You can select any one of eight types of presets. (When no names have been assigned, you select from among NAME1 through NAME8.)

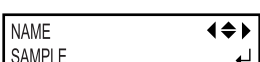
If you load a preset while  is illuminated,  goes dark. To start printing, press  once more and redo the preparations for printing.

## Assigning a Name to a Preset

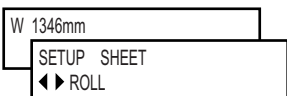
### Procedure

- 1  Press .  
Press .  
Press  twice.
- 2  Press .  
Use   to select any one from NAME1 to NAME8.
- 3  Press  twice.  
Use   to enter a character.
- 4  Press .  
Use   to enter the next character.  
Enter the following characters in the same way.  
When you're finished entering text, press .
- 5  Press .  
Press  to go back to the original screen.

### Description











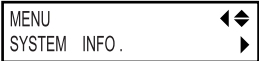





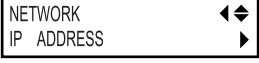



This assigns a name to a saved preset. Using media names may aid recognition and clarity.

The characters you can enter are "A" through "Z," "0" through "9," and the "-" character. You can enter up to 15 characters, including spaces.

# 6-11 Making the Network Settings

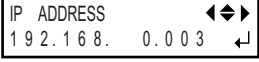
## Setting IP address, Subnet mask, etc.

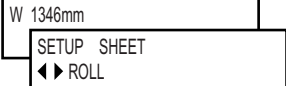
### Procedure

- 1**  Press .  
Press  several times.
- 2**  Press .  
Press .
- 3**  Press .  
Use   to choose the item whose setting you want to make.
- 4**  Press  twice.  
Use   to select the address number.
- 5**  Press .
- 6**  Repeat **4** and **5** to set all the address numbers.  
When you have finished making the setting, press .
- 7**  Press .  
Press  to go back to the original screen.

### Description

Make sure the machine is connected to the network by an Ethernet cable.  
For detailed information about the settings, consult your network administrator.

[IP ADDRESS]: IP address









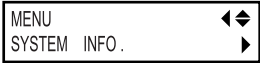

[SUBNET MASK]: Subnet mask

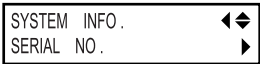
[GATEWAY ADDRESS]: Gateway address

# 6-12 Viewing System Information

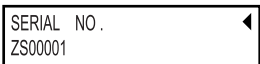
## Viewing the Serial Number, Firmware Version, and Other Information

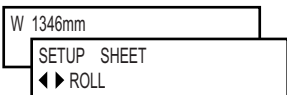
### Procedure

-  Press .  
Press  several times.
-  Press .  
Use   to choose the information you want to view.
-  Press .
-  Press .  
Press  to go back to the original screen.

### Description

You can view the following information.

[MODEL]: model name











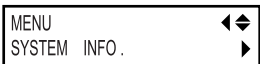

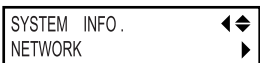
[SERIAL NO.]: serial number

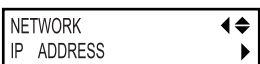
[INK]: ink type

[FIRMWARE]: firmware version

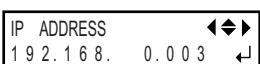
## Viewing the Network Settings

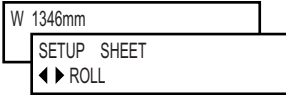
### Procedure

-  Press .  
Press  several times.
-  Press .  
Press .
-  Press .  
Use   to choose the information you want to view.
-  Press  two times.
-  Press .  
Press  to go back to the original screen.



---

## Description

---

You can view the following information.

[IP ADDRESS]: IP ADDRESS

[SUBNET MASK]: SUBNET MASK

[GATEWAY ADDRESS]: GATEWAY ADDRESS

[MAC ADDRESS]: MAC ADDRESS

## Printing a System Report



---

### Procedure

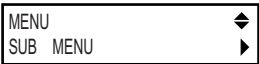

---

- 1**





Press .  
Press  several times.
- 2**

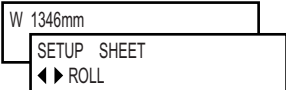

Press .  
Press  several times.  
Press  to start printing,
- 3**



Press .  
Press  to go back to original screen.

---

### Description









---

This prints system information, including a list of setting values.

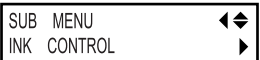
# 6-13 Performing Maintenance

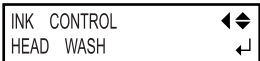
## Draining Ink and Performing Internal Washing

### Procedure









-  Press .  
Press  several times.
-  Press .  
Press  twice.
-  Press .  
Press  twice.  
Press  to execute.

### Description

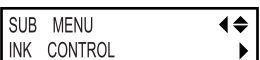
This drains the ink inside the printer and washes the interior using cleaning cartridges as a preliminary for moving the printer or conducting maintenance. This operation requires eight unused cleaning cartridges. The screen displays information such as instructions to insert and remove cartridges. Follow these instructions to carry out the procedure. After finishing washing, the sub power is switched off. You do not need to carry this out as part of your daily maintenance activities.

## Draining Ink Remaining Inside the Machine

### Procedure

-  Press .  
Press  several times.
-  Press .  
Press  twice.
-  Press .  
Press .  
Press  to execute.

### Description

This removes ink inside the printer as a preliminary procedure for performing maintenance. The screen displays information such as instructions to insert and remove cartridges. Follow these instructions to carry out the procedure. After finishing washing, the sub power is switched off. You do not need to carry this out as part of your daily maintenance activities.

# 6-14 Menu List

## Main menu

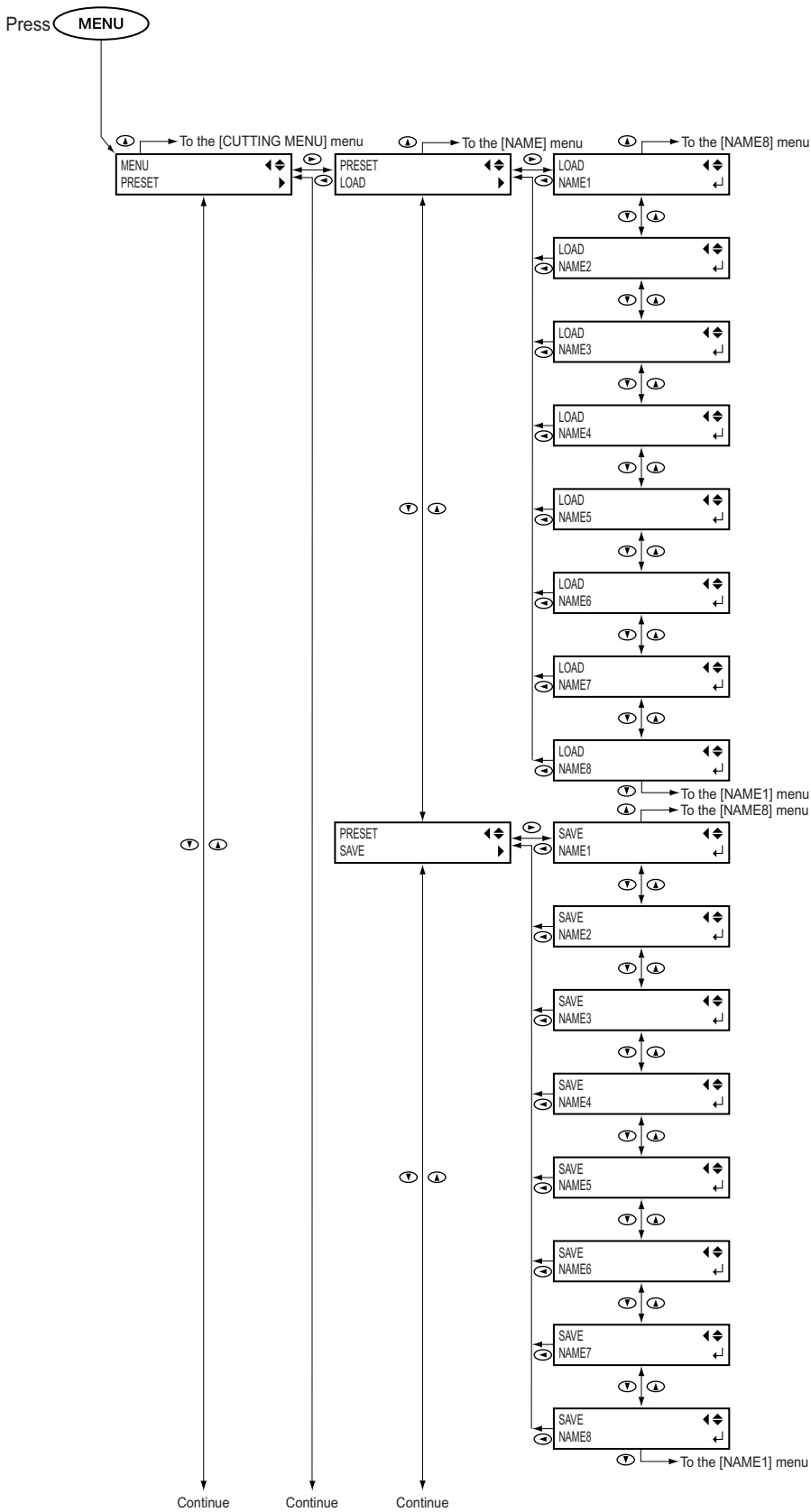

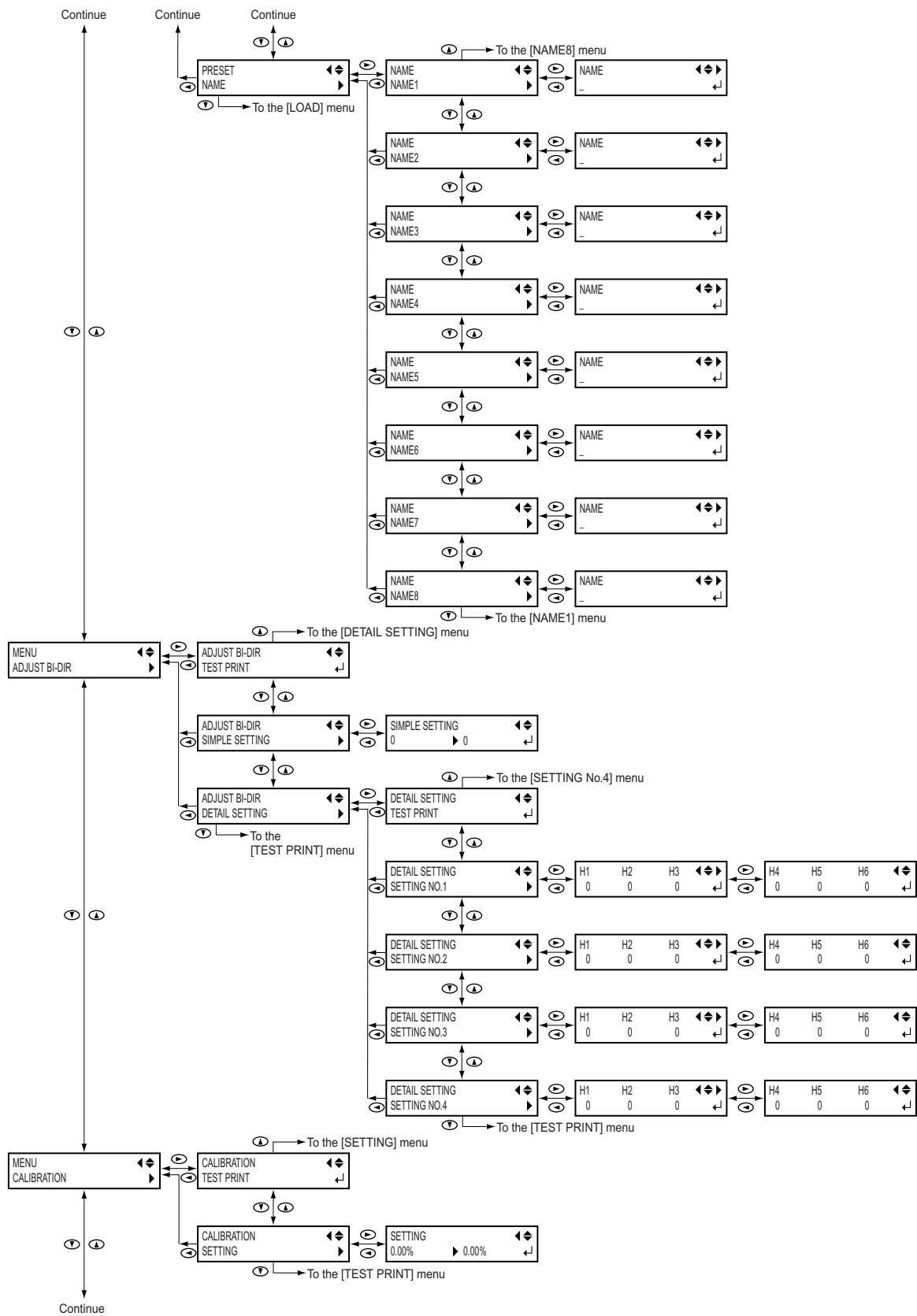

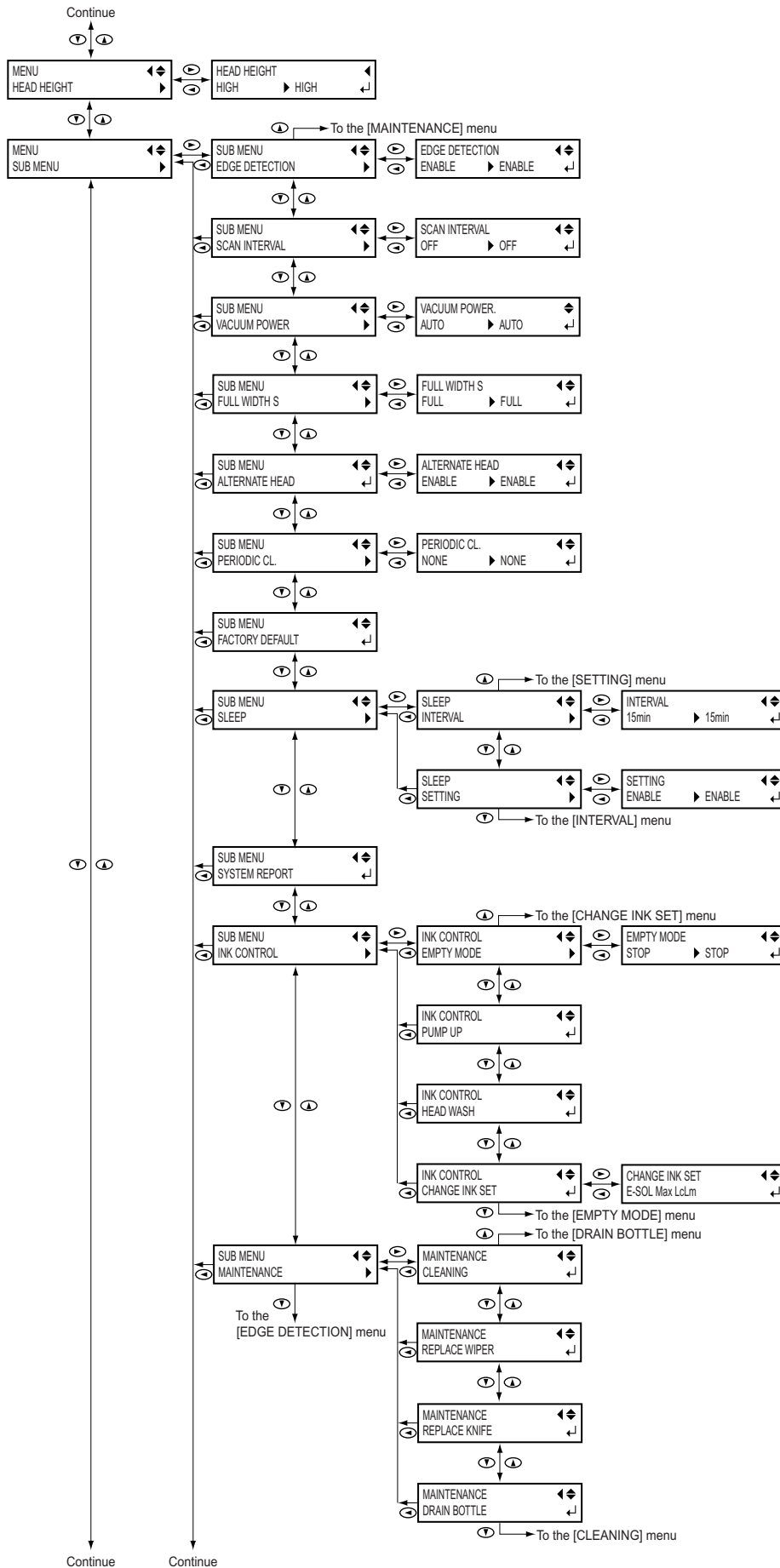

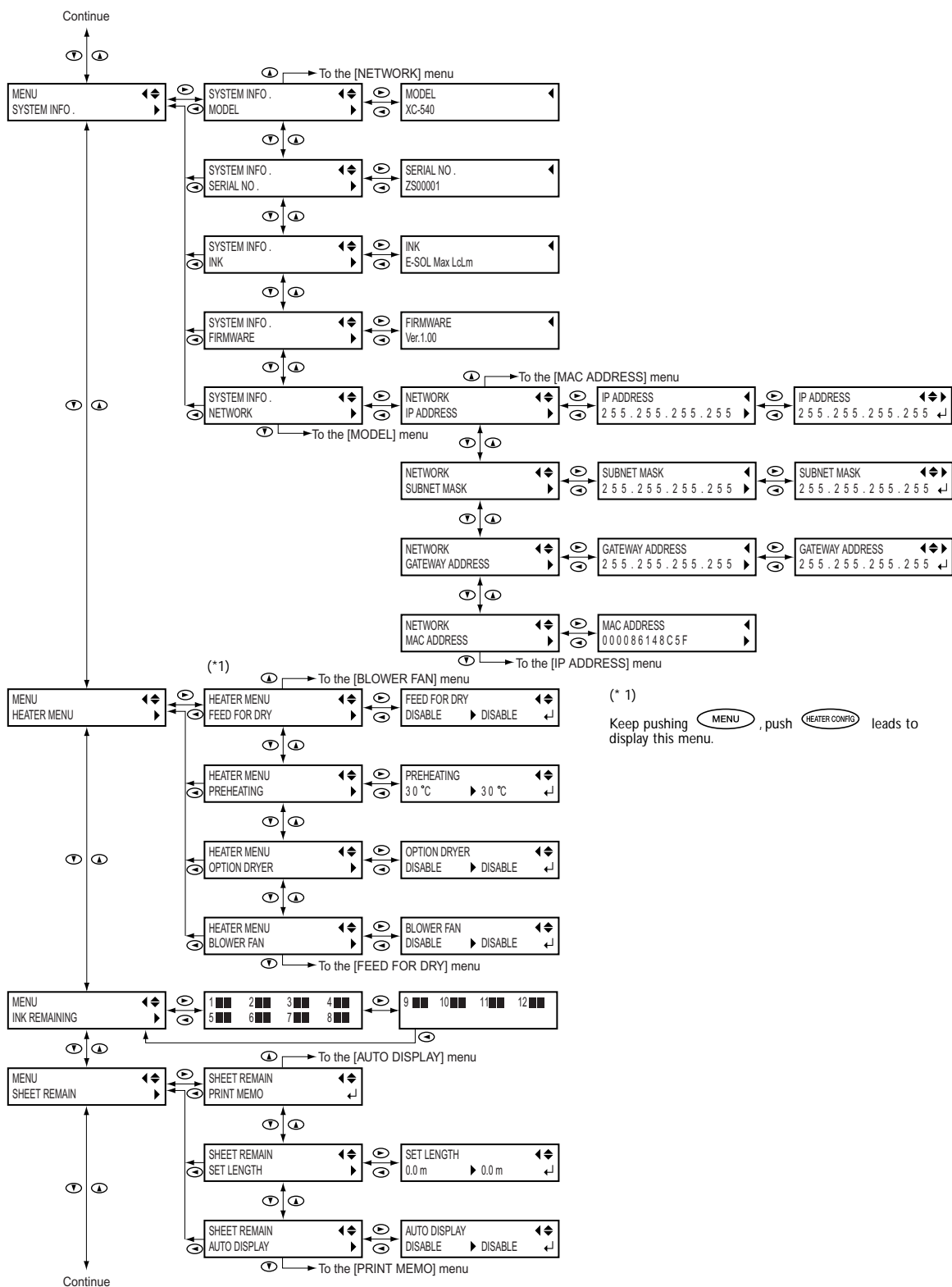

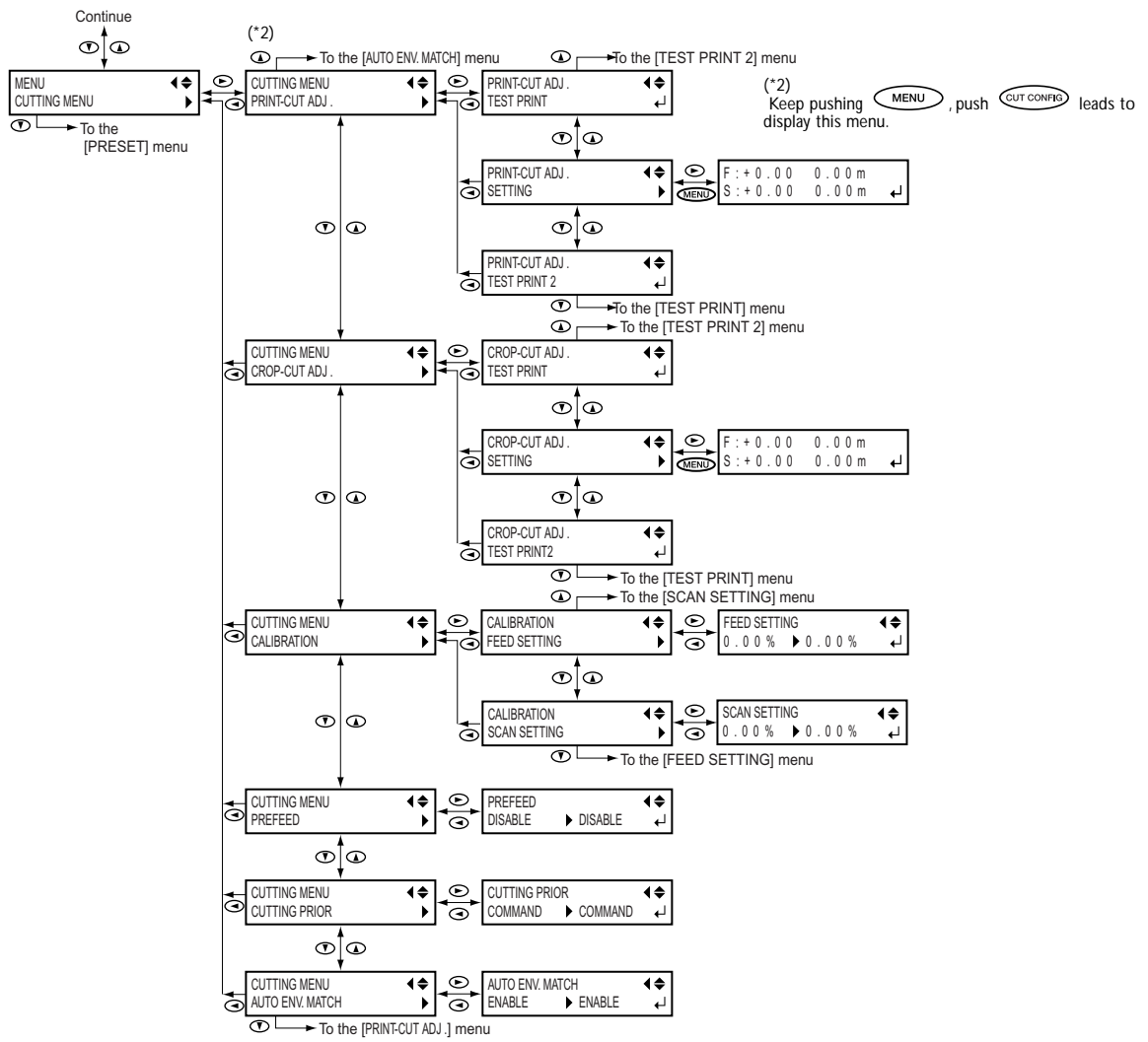

## Langage and Unit Menu

Hold down **MENU** and switch on the sub power.

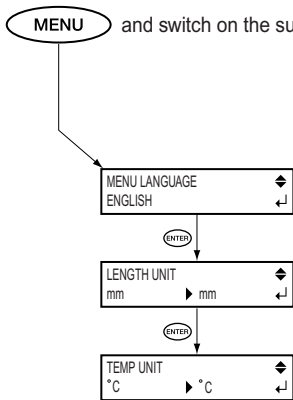

## Cleaning Menu

Press **CLEANING**

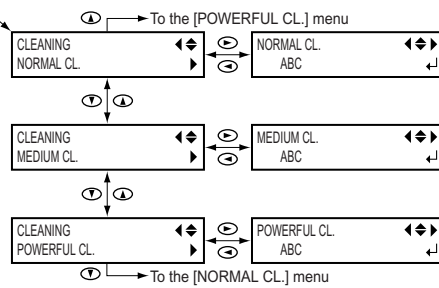

Hold down **CLEANING** for one second or longer

Head cleaning for all group  
 P.41 (When you want to clean all heads simultaneously)

## Heater Configuration Menu

Press **HEATER CONFIG**

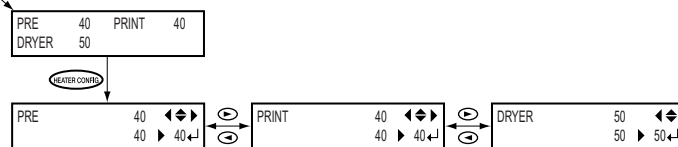



## Cut Configuration Menu

Press (CUT CONFIG)

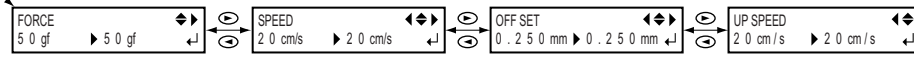



# *Chapter 7*

## *What to Do If*

---

# 7-1 The Machine Doesn't Run

## The Printer Unit Doesn't Run

### Is the power switched on?

Switch on the printer's main power, then press the sub power switch and make sure the sub power switch lights up.

### Is **SET UP** illuminated?

Printing is not performed when **SET UP** is not illuminated. Pull back the loading lever, close the front cover, and press **SET UP**.

### Is the front cover open?

Close the front cover.

### Is the top menu displayed?

If the top menu isn't displayed, output doesn't start even when data is sent from the computer. To go to the top menu, press **MENU**, then press **◀**.

### Is **PAUSE** illuminated?

When **PAUSE** lights up, operation is paused. To resume, press **PAUSE**. **PAUSE** goes dark and printing resumes.

### Has ink run out?

When printing data is sent while the screen shown in the 

1	2	3	4
5	6	7	8

 figure is displayed, a message appears and a warning beep sounds. At the same time, operation pauses. When the ink cartridge is replaced with a new one, printing or cutting starts.

☞ P.91 "Determining What Happens When an Ink Cartridge Is Empty"

### Is a message displayed on the screen?

☞ P.137 "If a Message Appears"

☞ P.138 "If an Error Message Appears"

### Is the cable connected?

Connect the cable securely.

### Is the network connection correct?

Check the port setting for the software RIP. In the software RIP, specify the IP address assigned to the Roland-PrintServer.

Make sure the network routing is suitable. Try connecting the computer and the machine to the same hub, or connecting then directly using a crossover cable. If this makes it possible to perform outputting, it means the problem is in the network itself.

Make sure the green light is on. If the light is dark, the network connection is not correct.

If output is impossible even though the green light is on, make sure the IP address and other settings are correct. The settings on both the machine and the computer must be

correct. Try making the settings again as you check for duplicate IP addresses and typing errors.

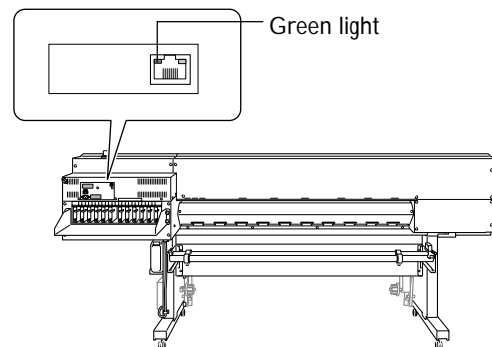

## The Media Take-up System Doesn't Run

### Is the cable connected?

Connect the cable for the take-up unit to the machine. To perform take-up automatically during printing, also make the setting for the AUTO switch.

☞ "Setup Guide"

## The Media Heating System Doesn't Warm Up

### Is media loaded?

The media heating system does not warm up to the preset temperature when **SET UP** is dark (by default). Load media, press **SET UP**, and wait for the machine to warm up.

☞ P.110 "Setting How the Media Heating System Operates"

### Is the temperature of the room too low?

Use the machine in an environment where the temperature is 20 to 32°C (68 to 90°F).

# 7-2 Attractive Printing/Cutting Is Impossible

## Printed Results Are Coarse or Contain Horizontal Stripes

### Do the print heads show dot drop-out?

Carry out a printing test and make sure no dot drop-out occurs. If dot drop-out is present, perform head cleaning.

- ☞ P.40 "Printing Tests and Cleaning"
- ☞ P.66 "When Head Cleaning Is Not Effective"

### Have you carried out feed correction?

Large misalignment in the amount of feed of the media may result in printing that seems coarse or contains horizontal stripes. Either make the setting on the computer to match the type of media you're using, or make the setting for correction on the printer.

- ☞ P.103 "Performing Feed Correction to Alleviate Horizontal Bands and the Like"

### Have you carried out bidirectional correction?

When you are performing bidirectional printing, use the [ADJUST BI-DIR] menu item to carry out correction. The optimal adjustment value may vary, depending mainly on the thickness of the media. Set or select an adjustment value that is suited to the media.

- ☞ P.100 "Correcting for Misalignment in Bidirectional Printing"
- ☞ P.101 "Correcting for Misalignment in Bidirectional Printing More Precisely"

### Is the media heating system at a suitable temperature?

If the ink forms lumps or smudges, raise the temperature. Note, however, that a temperature that is too high may degrade the media or cause it to wrinkle.

- ☞ P.36 "Settings of the Media Heating System"

### Is the temperature of the room too low?

The media heating system may not warm up sufficiently when the temperature is 20°C (68°F) or lower. Also, even when the media heating system reach their preset temperatures, adequate effectiveness may not be apparent if the media is thoroughly chilled. Before printing, allow the media to come to room temperature.

### Is the print mode suitable?

If attractive printing is impossible even when the media heating system is at a high temperature, try using a higher-quality print mode.

Depending on the media, smudging may occur when using a high-quality print mode, and results may also vary greatly depending on the settings of your RIP program (such as the color-profile selection). Make settings suited to the media you're using.

### Is the printer installed in a level and stable location?

Never install the machine in a location where it is tilted or where it may wobble or experience vibration. Also

make sure that the print heads are not exposed to moving air. These factors may lead to missing dots or reduced printing quality.

### Is the media loaded and set up correctly?

If the media is not loaded and set up correctly, media feed may not be smooth, or printing may be adversely affected.

- ☞ P.135 "Media Wrinkles or Shrinks, or Feed Is Unstable"

### Are the settings for the [PRESET] menu item appropriate?

If the settings selected with the [PRESET] menu item are not suitable for the type of media, printing may be adversely affected. Choose settings optimized to the media you're using.

- ☞ P.114 "Saving Optimized Media Settings As Preset Values"
- ☞ P.116 "Loading a Saved Preset"

## Colors Are Unstable or Uneven

### Did you shake the ink cartridges gently before installing them?

Before you install a new ink cartridge, gently shake the cartridge.

### Was printing paused partway through?

When printing is paused, the coloring at the seam may be altered when printing resumes. Avoid pausing printing. By default, printing pauses when ink remaining inside the machine runs out. Before you perform lengthy printing, check the amount of ink remaining in the ink cartridges.

Printing may also pause when data is not sent from the computer quickly enough.

### Are the operating parameters set to appropriate values?

Depending on the settings for such menu items as [FULL WIDTH S] and [PERIODIC CL.], uneven colors may occur. If the settings have been changed, try restoring them to their default values.

- ☞ P.88 "Speeding Up Printing for Narrow Media"
- ☞ P.88 "Keeping Media from Being Soiled by Ink Drops"

### Is the printer installed in a level and stable location?

Never install the machine in a location where it is tilted or where it may wobble or experience vibration. Also, ensure that the printing heads are not exposed to wind or blown air. These factors may lead to missing dots or reduced printing quality.

### Are the settings for the [PRESET] menu item appropriate?

If the settings selected with the [PRESET] menu item are not suitable for the type of media, printing may be adversely affected. Choose settings optimized to the media you're using.

☞ P.114 "Saving Optimized Media Settings As Preset Values"

☞ P.116 "Loading a Saved Preset"

### The Media Becomes Soiled When Printed

#### Do the print heads contact the media?

The height of the print heads may be too low. Also, if the media is not loaded and set up correctly, it may wrinkle or come loose and strike the heads.

☞ P.135 "Media Wrinkles or Shrinks, or Feed Is Unstable"

☞ P.85 "Adjusting Head Height to Match Media Thickness"

#### Are the print heads dirty?

The following may cause ink to drip on the media during printing.

- Buildup of fibrous dust (lint) around the heads.
- Ink transferred to the heads due to rubbing against the media.

If this happens, clean the heads using the cleaning kit. We recommend carrying out periodic head cleaning.

☞ P.68 "Cleaning the Heads Using the Cleaning Kit"

#### Are the pinch rollers dirty?

Periodically clean the pinch rollers.

### Cutting Is Misaligned or Skewed

#### Is the media loaded and set up correctly?

If the media is not loaded and set up correctly, or media feed may not be smooth, cutting may be adversely affected. Make sure the media is loaded and set up correctly.

☞ P.135 "Media Wrinkles or Shrinks, or Feed Is Unstable."

#### Are the settings for the cutting conditions appropriate?

Misalignment or skewing may occur if the cutting speed is too fast or the blade force is too high. Try changing the cutting conditions. With media having a strong adhesive layer, the adhesive layer reattaches to itself immediately after cutting. However, a cutting test shows that the peeling of the media and the blade traces on the backing paper are optimal, then the media is being cut properly. Be careful not to make the blade force too high.

#### Is the length of printing too long?

For printing followed immediately by cutting in particular, the longer the page length (that is, the longer the distance the media is returned after printing), the greater is the chance of misalignment occurring. It is a good idea to keep the size of each single page to the minimum necessary.

#### Are you using media that exhibits large expansion and contraction?

When you're performing printing followed immediately by cutting, misalignment occurs if the media expands or contracts. If this happens, try performing printing with crop marks, then setting the base point and one or more align points and performing cutting. This corrects for expansion and contraction of the media.

#### Is [AUTO ENV. MATCH] set to the "DISABLE" setting?

The printing and cutting positions may become misaligned due to ambient temperature or humidity. Setting [AUTO ENV. MATCH] to "ENABLE" performs matching to the environment to correct for misalignment.

☞ P.84 "Making the Setting for Automatic Adjustment of the Printer to the Operating Environment"

#### Is the [CALIBRATION] setting during cutting correct?

When you're performing printing followed by cutting, go to the [CUTTING MENU] and set the [CALIBRATION] value to "0.00".

☞ P.97 "Performing Distance Correction During Cutting"

## 7-3 The Media Jams

### The Media Jams

**If an error message is displayed because the media has jammed, immediately correct the problem. Failure to do so may damage the print heads.**

☞ P.139 [MOTOR ERROR TURN POWER OFF]

#### **Is the media warped or wrinkled?**

Many factors can cause warping or wrinkling. Refer to the following and correct the problem.

☞ P.135 "Media Wrinkles or Shrinks, or Feed Is Unstable"

#### **Is the height of the print heads too low?**

Try raising the heads higher. Media may inevitably warp or wrinkle slightly, so adjust the height of the heads to take this into account.

☞ P.85 "Adjusting Head Height to Match Media Thickness"

# 7-4 The Media Cannot Be Taken Up Smoothly

## The Media Cannot Be Taken Up Smoothly

### Is media feed unstable?

Various factors can make media feed unstable. Refer to the following and correct the problem.

☞ P.135 "Media Wrinkles or Shrinks, or Feed Is Unstable"



# 7-5 Media Wrinkles or Shrinks, or Feed Is Unstable

A variety of problems can occur if the media feed is not smooth. This can cause such problems as poor printing quality, contact with the media by the print heads, misaligned positioning, media jams, or poor take-up. Take action as follows.

## Media Wrinkles or Shrinks

### **Is the media loaded and set up straight and securely?**

Feed is not smooth when the media is not straight or tensioned unevenly on the left and right. Reload the media.

### **Was loaded media allowed to stand for some time?**

Media may shrink or wrinkle, if it is heated for an extended time. When printing ends, switch off the sub power or remove the media.

### **Are the media clamps mounted?**

When you're performing printing, be sure to attach the media clamps.

### **Was the media loaded while the heating devices were hot?**

Loading media after the heating devices have warmed up causes the temperature of the media to rise suddenly, which may cause the media to shrink or wrinkle during printing. Before loading media, switch off the sub power and allow them to cool.

### **Is the temperature of heating device too high?**

Set the temperature to suitable values for the type of media.  
☞ P.36 "Settings of the media heating system"

## Media Feed Is Not Straight

### **Is the media loaded and set up straight and securely?**

Feed is not smooth when the media is not straight or tensioned unevenly on the left and right. Reload the media.

## Media Feed Is Not Smooth

### **Does the media or the shafts strike some other object?**

Make sure the media and the shafts do not touch anything else. This may affect output, even when feed appears to be smooth.

### **Is the media too thick?**

Media that is too thick may not only cause unstable feed, but may scrape the print heads, resulting in malfunction. Never use such media.

### **Are the grit rollers dirty?**

Check to make sure the grit rollers are free of buildup of foreign material such as media scraps.

# 7-6 The Print Heads Stopped Moving

If the print-head carriage stops over the platen, take action immediately to prevent the heads from drying out.

## What to Do First

Switch the sub power off, then back on again. (If the media is jammed, then also remove the media.) If the heads move to the standby position (right side of the main unit), it means the operation has ended successfully.

If the heads did not move, try switching off the main power, then again switching on the main power, followed by the sub power.

## If the Heads Still Do Not Move

If the heads still do not move, carry out the following emergency response measure, then contact your authorized Roland DG Corp. dealer or Roland DG Corp. service center.

1. Switch off the main power.
2. Open the front cover.
3. Gently move the print heads by hand as far as the standby position.

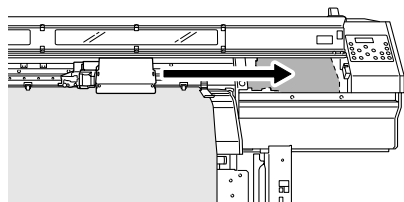

4. Insert the head-unit tool into the hole at the bottom of the machine and turn gently. The cap-unit rises.

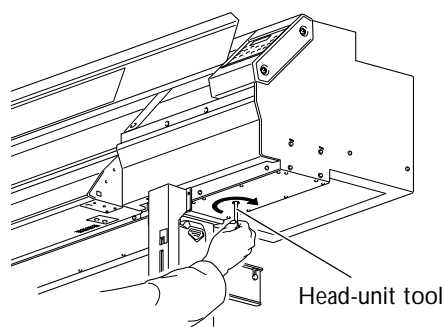

5. Make the guides at the edges of the print heads line up with the guides at the edges of the cap unit. Turn the tool further to bring the cap unit near the heads.

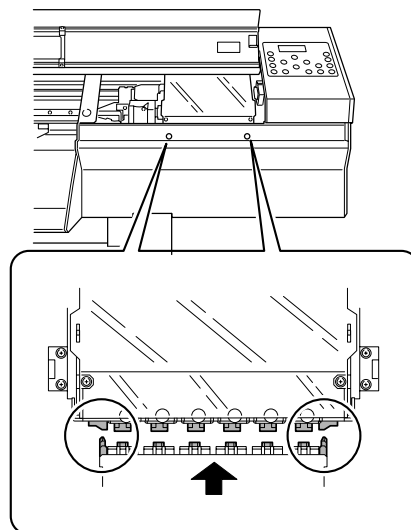

6. When the heads make contact with the cap-unit, turn the tool one or two more turns.

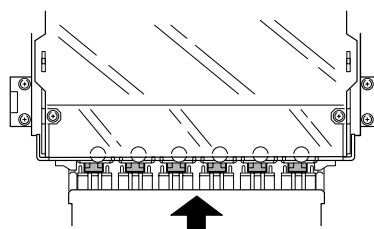

Make sure the print heads are capped tightly.

## 7-7 If a Message Appears

These are the main messages that appear on the machine's display to prompt correct operation. They do not indicate any error. Follow the prompts and take action accordingly.

### [1 ■ 2 ■ 3 ■ 4 ■ ...]

Only a small amount of ink remains. Replace the cartridge indicated by the flashing number with a new cartridge.

### [PRESS POWER KEY TO CLEAN]

This appears when the machine has been unused for about one month.

This feature is to remind you to switch on the sub power once a month.

☞ P.78 "When Not in Use for a Prolonged Period."

### [SET SOL CRT.]

Insert the ink cartridge indicated by the flashing number. This message appears at times such as during cartridge replacement.

### [REMOVE SOL CRT.]

Remove the ink cartridge indicated by the flashing number. This message appears at times such as during head cleaning.

### [SET SOLCL-LIQUID]

Insert the cleaning cartridge indicated by the flashing number. This message appears at times such as during cartridge replacement.

### [REMOVE SOLCL-LIQUID]

Remove the cleaning cartridge indicated by the flashing number. This message appears at times such as during head cleaning.

### [SET CARTRIDGE.]

Insert the ink cartridge indicated by the flashing number. This message appears at times such as during cartridge replacement.

### [END OF THE SHEET]

The trailing edge of the media was detected during operation. Press any button on the operation panel to clear the message. Load new media.

### [SHEET NOT LOADED PRESS SETUP KEY]

Load media and press **SET UP**. This message appears when an attempt to perform a printing test was made while no media was loaded.

### [INSTALL DRAIN BOTTLE]

Check whether the drain bottle is installed. Install the drain bottle, then press **ENTER**.

### [CHECK DRAIN BOTTLE]

This appears when a certain amount of discharged fluid collects in the drain bottle. To clear the message, press **ENTER**. If this screen appears, go to the [DRAIN BOTTLE] menu and discard the discharged fluid in the bottle.

☞ P.62 "Disposing of Discharged Ink"

### [NOW HEATING...]

Wait until the preheater, print heater and dryer reach the preset temperature. Printing starts when **HEATER CONFIG** lights up. You can stop printing by holding **SET UP** for one second or longer while this is displayed. Pressing **PAUSE** makes printing start immediately, without waiting to reach the preset temperature.

### [CLOSE THE FRONT COVER]

Close the front cover.

For safety, the carriage do not operate while a cover is open.

### [SET HEAD HEIGHT TO xxx]

The height of the print heads is lower than the height specified on the computer.

The heads move to a location where you can operate the height-adjustment lever. Adjust to the displayed height, then press **ENTER**.

### [REMOVE MEDIA CLAMPS]

This appears if **SHEET CUT** is pressed while the media clamp is attached. Remove the media clamp and press **ENTER**.

### [TIME FOR MAINTENANCE]

It is time to clean the heads using the cleaning kit. After verifying, press **ENTER**.

☞ P.68 "Cleaning the Heads Using the Cleaning Kit"

### [TIME FOR WIPER REPLACE]

It is time to replace the wiper. After verifying, press **ENTER**.

☞ P.72 "Replacing the Wipers"

# 7-8 If an Error Message Appears

This describes the error messages that may appear on the machine's display, and how to take action to remedy the problem. If the action described here does not correct the problem, or if an error message not described here appear, contact your authorized Roland DG Corp. dealer.

## [ALIGN POINT POSITION INVALID]

**An attempt was made to set an align point at a location where the setting cannot be made.**

No align point can be set when the angle of the base point and the align point is too large.

Reload the media correctly, so that the angle is minimized, then set the base point and the align point again to match the crop marks.

☞ P.51 "Performing Cutting with Automatic Crop-mark Detection"

## [OPTION-DRYER IS NOT CONNECTED]

When the drying-heater unit is not connected to the printer, [OPTION DRYER] is set to "ENABLE". Switch the sub power and main power off, and then connect the drying heater unit to the printer.

## [CAN'T PRINT CROP CONTINUE?]

**The size of the data including the crop marks is larger than the printing or cutting area of the loaded media.**

To continue performing output without correcting this, press **ENTER**. At this time, the portion extending beyond the printing or cutting area and crop marks is not printed. To stop output, stop sending data from the computer, then raise the loading lever. Make the printing or cutting area wider such as by replacing the media with a larger piece of media or by changing the positions of the pinch rollers, then send the data again.

**The size of the data being output is too small.**

Make the scanning direction size of the data at least 65 mm (2-9/16 in).

To continue performing output without correcting this, press **ENTER**. At this time, the data is output without printing the crop marks. To stop output, stop sending data from the computer, hold down **SET UP** for one second or longer. Change the size of the data, then send the data again. There is no limitation in the data size in media-feed direction.

## [CARRIAGES ARE SEPARATED]

**The cutting carriage and the printing carriage were improperly disconnected.**

A problem such as a media jam occurred, impeding correct operation. Operation cannot be continued. Switch the sub power off, then back on.

## [CROPMARK ERROR NOT FOUND]

**Automatic detection of crop marks could not be accomplished.**

Load the media at the correct position and perform detection of crop marks again. Depending on the media, it may not be possible to detect crop marks automatically. If re-peating automatic crop-mark detection results in an error again, then perform manual crop-mark detection.

☞ P.52 "Aligning Manually and Cutting"

## [DATA ERROR CANCELING...]

**Output was stopped because a problem was found in the data received.**

Operation cannot be continued. Check whether the data contains errors. Also, check for a problem with the connector cable or the computer, and redo the operation from the step of loading the media.

## [HEAD HEIGHT ERROR]

**The height-adjustment lever for the print heads was operated improperly.**

Operation cannot be continued. Switch the sub power off, then back on. To change the head height, use the [HEAD HEIGHT] menu.

☞ P.85 "Adjusting Head Height to Match Media Thickness"

## [HEATING TIMEOUT CONTINUE?]

**The preheater or print heater did not reach the pre-set temperature.**

This occurs because the temperature of the location where the machine is installed is too low. We recommend raising the temperature. To quit printing, hold down **SET UP** for one second or longer. To continue waiting for the temperature to rise, press **ENTER**. To start printing immediately, press **PAUSE**.

## [PINCHROLL ERROR INVALID RIGHT POS]

**The right pinch roller is positioned at a location where it does not pinch the media.**

Raise the loading lever and move the right pinch roller to the correct location.

☞ P.30 "Loading and Cutting Off Media"

## [PINCHROLL ERROR INVALID LEFT POS]

**The left pinch roller is positioned at a location where it does not pinch the media.**

Raise the loading lever and move the left pinch roller to the correct location.

☞ P.30 "Loading and Cutting Off Media"

**[PINCHROLL ERROR LOWER PINCHROLL]**

**SET UP** was pressed without first lowering the pinch rollers.

Press any key to clear the error. Pull back the loading lever, then press **SET UP**.

The pinch rollers were raised while **SET UP** was illuminated.

The error is cleared automatically after a short wait. Never move the loading lever while printing is in progress.

**[SERVICE CALL xxxx]**

**An unrecoverable error occurred, or part replacement that must be performed by a service technician is required.**

Note the number displayed, then switch off the sub power. After you switch off the power, inform your authorized Roland DG Corp. dealer of the number that appeared on the display.

**[SHEET TOO SMALL CONTINUE?]**

**The size of the data is larger than the printing or cutting area of the loaded media.**

To continue performing output without correcting this, press **ENTER**. At this time, the portion extending beyond the printing or cutting area is not output. To stop output, stop sending data from the computer, hold down **SET UP** for one second or longer. Make the printing or cutting area wider such as by replacing the media with a larger piece of media or by changing the positions of the pinch rollers, then send the data again.

**[SHEET SET ERROR SET AGAIN]**

**SET UP** was pressed even though no media is loaded. Press any key to clear the error. Load media and pull back the loading lever, then press **SET UP**.

**[EDGE DETECTION] is set to "ENABLE", but transparent media was loaded.**

Raise the loading lever, set the [EDGE DETECTION] menu item to [DISABLE], then reload the media.

☞ P.86 "Using Transparent Media"

**The loaded media is too small.**

Press any key to clear the error. Replace with media of usable size.

**[TEMPERATURE IS TOO HIGH \*\*°C]**

**The temperature of the location where the machine is installed has risen above the ambient temperature at which the machine can operate.**

Operation cannot be continued. Switch off the sub power. The displayed temperature is room temperature of installation location now. Bring the installed location to a temperature at which operation is possible (15 to 32°C) and allow the machine to come to room temperature, then turn on the power.

**[TEMPERATURE IS TOO LOW \*\*°C]**

**The temperature of the location where the machine is installed has fallen below the ambient temperature at which the machine can operate.**

Operation cannot be continued. Switch off the sub power. The displayed temperature is room temperature of installation location now. Bring the installed location to a temperature at which operation is possible (15 to 32°C) and allow the machine to come to room temperature, then turn on the power.

**[AVOIDING DRY-UP TURN OFF POWER]**

**The print heads were forced to standby position to prevent them from drying out.**

Operation cannot be continued. Switch the sub power off, then back on. Opening the front cover while printing is in progress causes an emergency stop. Never allow the print heads to stand in this state.

**[MOTOR ERROR TURN POWER OFF]**

**A motor error occurred.**

Operation cannot be continued. Switch off the sub power. Next, eliminate the cause of the error, then immediately switch on the sub power. If the machine is allowed to stand with the error uncorrected, the print heads may dry out and become damaged.

This error may be caused by such factors as a mistake in loading the media, a media jam, or an operation that pulls the media with excessive force.

**The media has jammed.**

Carefully remove the jammed media. The print heads may also be damaged. Perform head cleaning, then perform a printing test and check the results.

**The media was pulled with excessive force.**

Excessive tension was applied to the media, and additional action is necessary to recover from this state. First, move the loading lever to the rear and adjust the media to create a small amount of slack, then switch on the sub power.

**[WRONG CARTRIDGE]**

**A cartridge that cannot be used was installed.**

Remove the cartridge to clear the error. Use a cartridge of the specified type.



# *Chapter 8*

## *Appendix*

---

# 8-1 Usable Media

## Conditions for Usable Media

### Media width

10-1/4 to 54 inches (260 to 1371 mm)

### A) Cuttable media thickness

0.08 to 0.22 mm (3.2 to 8.6 mil)  
(depending on media composition)

### B) Maximum media thickness (including backing paper)

Printing only : 1.0 mm (39 mil)  
When performing cutting : 0.4 mm (15 mil)

### C) Roll outer diameter

180 mm

### D) Paper tube (core) inner diameter

50.8 mm or 76.2 mm (2 inches or 3 inches)

### Roll weight

30 kg (66 lb.)

### Other conditions

Media such as the following cannot be used.

- Media having an inward curl (i.e., media whose print surface is on the inner side of the roll)
- Media whose end is attached to the paper pipe (core)
- Media which is severely warped or which has a strong tendency to reroll
- Media that cannot withstand the heat of the heating devices
- Media whose paper pipe (core) is bent or crushed

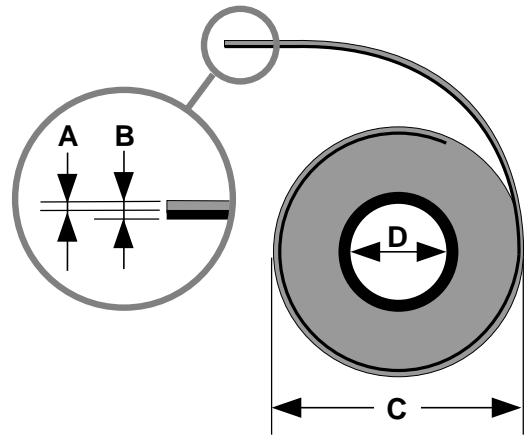

This machine cannot necessarily print every kind of media. When selecting media, be sure to carry out testing in advance to make sure that satisfactory printing quality is obtained.



## Acceptable Media Width

260 to 1371 mm (10-1/4 to 54 in.)

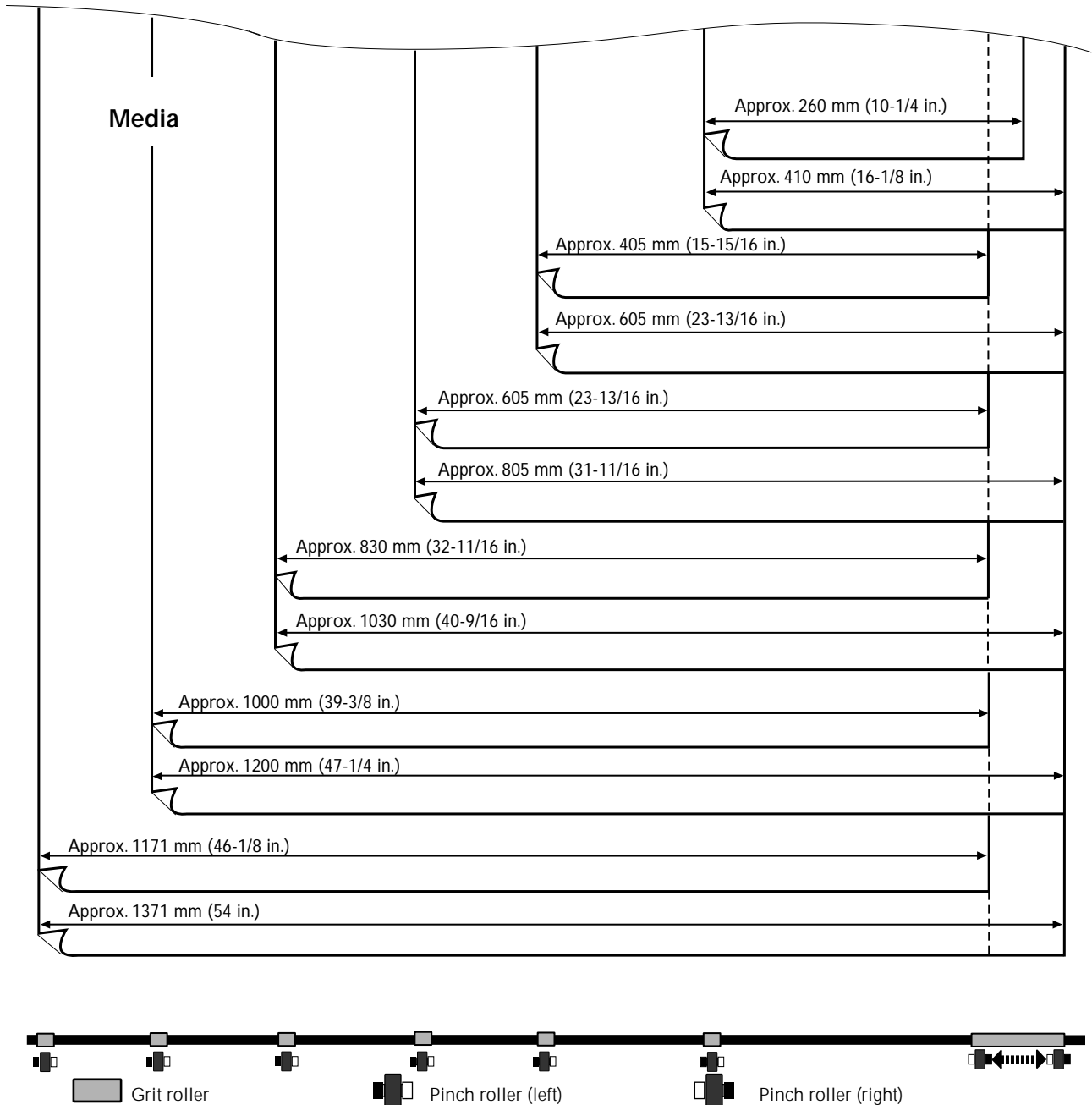

### Important!

Make sure the left and right pinch rollers are positioned above the grit rollers. Use the middle pinch roller as required. Position one (or both) middle pinch rollers so as to form equally spaced intervals along the width of the media.

# 8-2 Printing/Cutting Area

## Maximum Area

The printing or cutting area along the horizontal plane (the direction in which the carriage moves) is determined by the position of the pinch rollers.

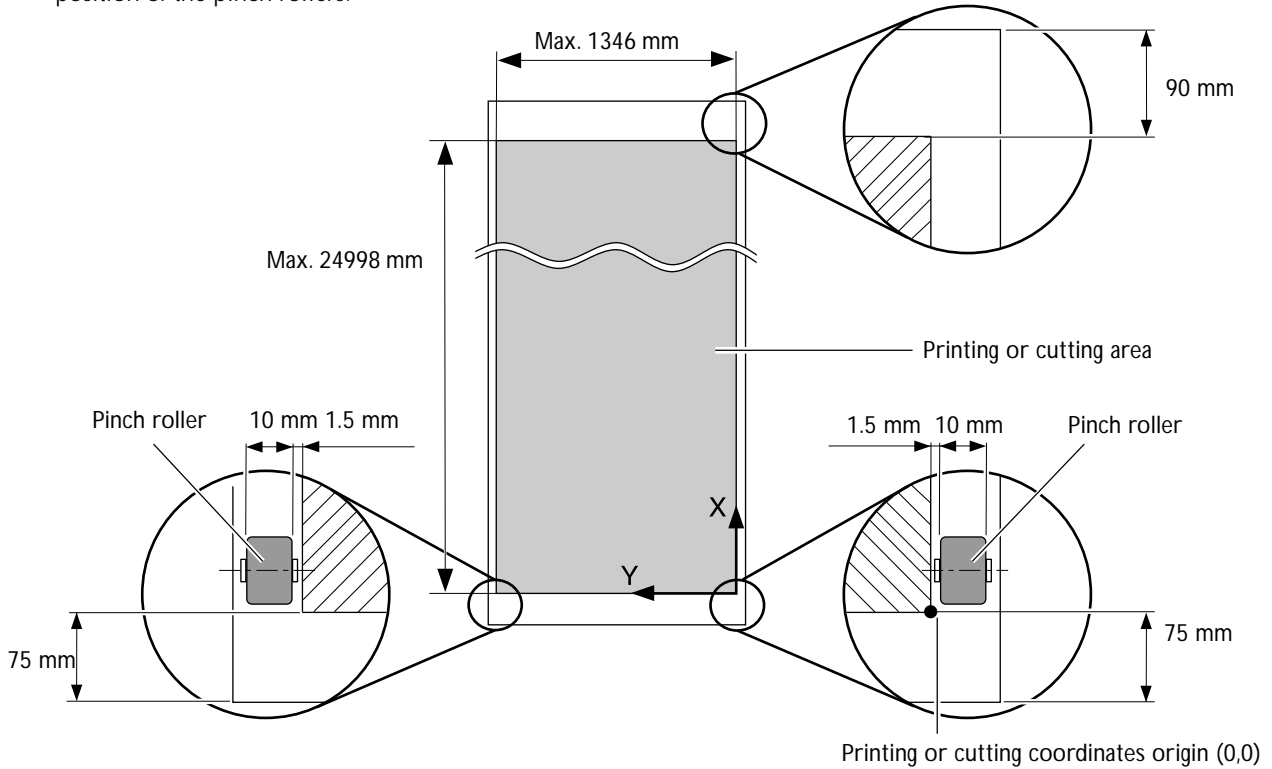

## Maximum Area When Using Crop Marks

When crop marks are used, the printing or cutting area is reduced from the maximum area by an amount equal to the crop marks.

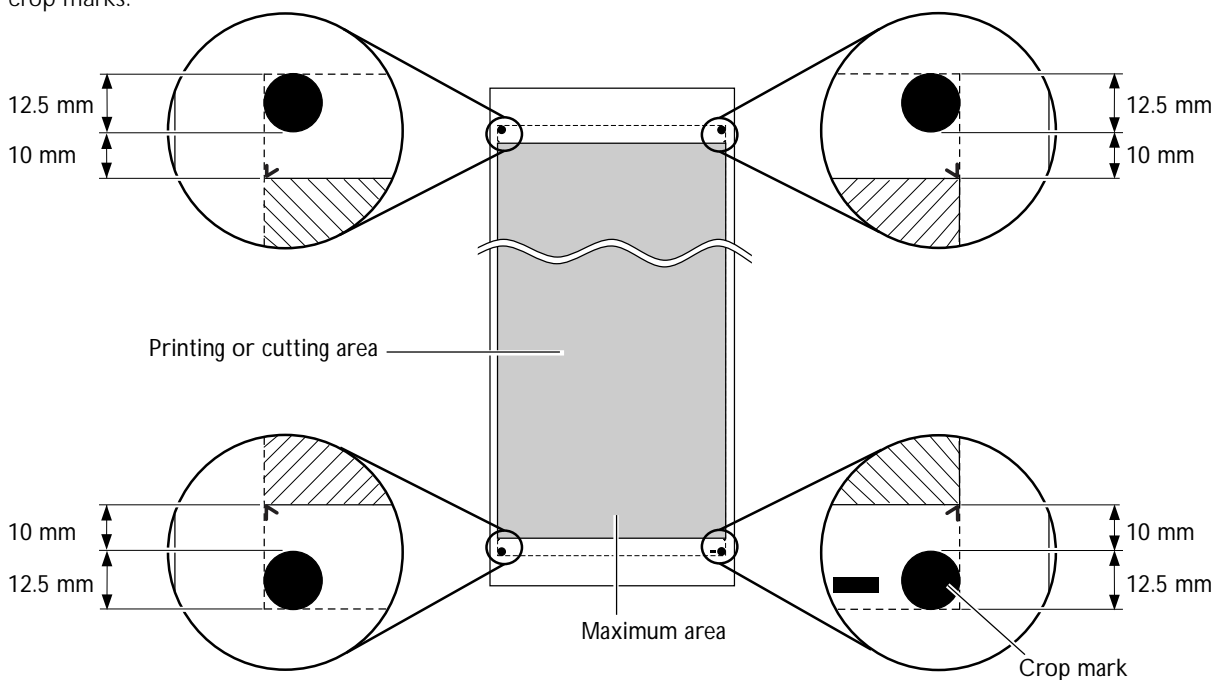

## The Media-cutoff Location During Continuous Printing

When a media-cutoff command is sent from the computer, the cutoff location on the media is as shown in the figure below.

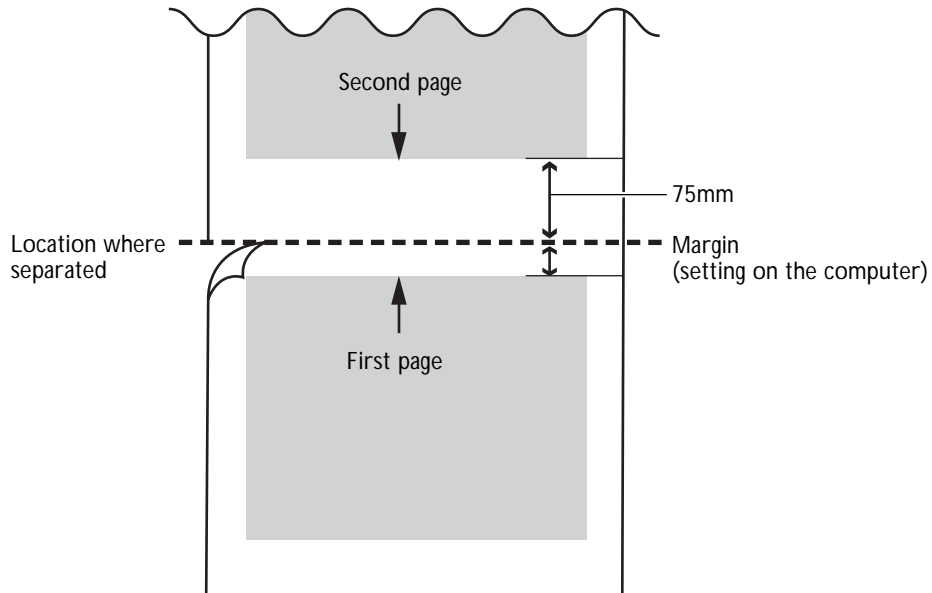

## 8-3 About the Blade

The cutting conditions and the service life of the blade change according to the media and the operating environment, even when using identical blades. The service life also differs according to the type of blade. A rough guide is shown below.

Blade	Media	Tool-force	Amount of cutter offset	Life of a blade* (General guide)
ZEC-U1005	General Signage Vinyl	50 to 150 gf	0.25 mm	8000 m
ZEC-U5025	General Signage Vinyl	30 to 100 gf	0.25 mm	4000 m
	Fluorescent Vinyl	120 to 200 gf	0.25 mm	4000 m
	Reflective Vinyl	100 to 200 gf	0.25 mm	4000 m

When uncut areas remain even when the blade force is increased to a value that is higher by 50 to 60 gf than the values shown in this chart, then replace the blade.

\*The values for "Life of a blade" are estimates for when cutting media of identical type.

## 8-4 Locations of the Power Rating and Serial Number Labels

### Serial Number

This is require when you seek maintenance, servicing, or support. Never peel off the label or let it get dirty.

### Power Rating

Use an electrical outlet that meets the requirements for voltage, frequency, and amperage given here.

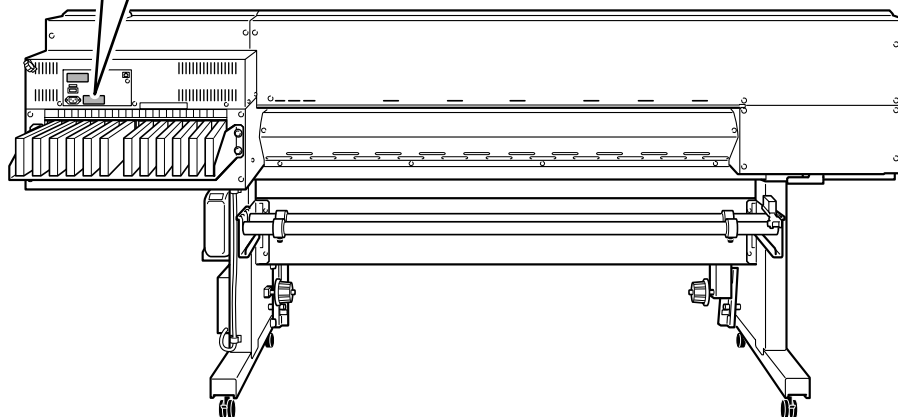

## 8-5 Specifications

		XC-540
Printing/Cutting method		Piezo ink-jet method/media-moving method
Acceptable media widths		260 to 1371 mm (10-1/14 to 54 in.)
Printing/Cutting width (*1)		Maximum 1346 mm (53 in.)
Ink cartridges	Types	ECO SOL MAX 220cc cartridge / 440cc cartridge
	Color	Six colors (cyan, magenta, yellow, black, light cyan, light magenta) or Four colors (cyan, magenta, yellow, and black)
Printing resolution (Printing dot resolution)		Maximum 1440 dpi
Acceptable tool		Special blade for CAMM-1 series
Cutting speed		10 to 600 mm/s (0 to 300 mm/s in media-feed direction)
Blade force		30 to 300 gf
Blade offset compensation		0.000 to 1.500 mm (0 to 0.0591 in.)
Software resolution (When cutting)		0.025 mm/step (0.000984 in./step)
Distance accuracy (When printing) (*2) (*3)		Error of less than $\pm 0.3\%$ of distance traveled, or $\pm 0.3$ mm, whichever is greater
Distance accuracy (When cutting) (*3)		Error of less than $\pm 0.4\%$ of distance traveled, or $\pm 0.3$ mm, whichever is greater When distance correction has been performed (when the setting for [CALIBRATION] - [CUTTING ADJ.] has been made): Error of less than $\pm 0.2\%$ of distance traveled, or $\pm 0.1$ mm, whichever is greater
Repetition accuracy (When cutting) (*3) (*5)		$\pm 0.1$ mm or less
Alignment accuracy for printing and cutting (*3) (*6)		$\pm 0.5$ mm or less
Alignment accuracy for printing and cutting when reloading media (*3) (*6)		Error of less than $\pm 0.5\%$ of distance traveled, or $\pm 3$ mm, whichever is greater
Dryer unit (*7)		Heating method, Setting range for the preset temperature: 30 to 50°C (86 to 122°F)
Ink -fixing device (*7)		Print heater / Preheater, Setting range for the preset temperature: 30 to 50°C (86 to 122°F)
Take up system	Roll outer diameter allowing take-up	Maximum 180 mm
	Weight allowing take-up	Maximum 30 kg
Interface		Ethernet (10BASE-T/100BASE-TX, automatic switching)
Power-saving function		Automatic sleep feature (compliant with the International ENERGY STAR® Office Equipment Program)
Power supply	Voltage and frequency	AC 100 to 120 V $\pm 10\%$ , 50/60 Hz or AC 220 to 240 V $\pm 10\%$ , 50/60 Hz
	Required power capacity	13 A (100 to 120 V) or 7 A (220 to 240 V)
Power consumption	During operation	Approx. 1600 W
	Sleep mode	Approx. 47 W
Acoustic noise level	During operation	64 dB (A) or less (according to ISO 7779)
	During standby	45 dB (A) or less (according to ISO 7779)
Dimensions (With stand)		2694 (W) x 1103 (D) x 1260 (H) mm (106-1/8 (W) x 43-7/16 (D) x 49-5/8 (H) in.)
Weight (With stand)		197 kg (434.3 lb.)
Environment	Power on (*8)	Temperature: 15 to 32°C (59 to 90°F) (20°C [68°F] or more recommended), humidity: 35 to 80% (no condensation)
	Power off	Temperature: 5 to 40°C (41 to 104°F), humidity: 20 to 80% (no condensation)
Included items		Exclusive stands, Power cord, Blade, Blade holder, Media clamp, Replacement blade for separating knife, Cleaning kit, Software RIP, User's manual etc.

\*1

The length of printing or cutting is subject to the limitations of the program or driver.

\*2

- At Roland PET film, print travel: 1 m
- Temperature: 25°C (77°F), humidity: 50%

\*3

Not assured when the print heater or dryer is used.

\*4

The following conditions must be met:

- Media type: Media specified by Roland DG Corp.
- Roll media must be loaded on the shaft
- [PREFEED] menu item must be set to [ENABLE]
- Side margins: 25 mm or more for both the left and right margins
- Front margin: 35 mm or more
- Excluding stretching/contraction of the media

Range for assured repetition accuracy

- For media with a width exceeding 610 mm: Length 4,000 mm
- For media with a width of 610 mm or less: Length 8,000 mm

\*5

- Provided that media length is under 3000 mm
- Temperature: 25°C (77°F)
- Excluding possible shift caused by expansion/contraction of the media and/or by reloading the media

\*6

- Media type : Roland PET film
- Data size: 1,000 mm in the media-feed direction, 1,346 mm in the carriage-movement direction
- No lamination
- Automatic detection of crop marks at 4 points when media is reloaded
- During cutting, [PREFEED] menu item must be set to [ENABLE]
- Temperature: 25°C (77°F)
- Excludes the effects of slanted movement and of expansion and contraction of the media

\*7

- Warm-up is required after powerup. This may require 5 to 20 minutes, depending on the operating environment.
- Depending on the ambient temperature and media width, the preset temperature fail to be reached.

\*8

Operating environment

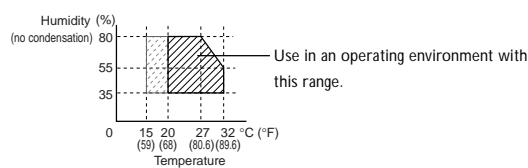









**About the GPL/LGPL software used in this product**

Thank you for purchasing our product.

This product is using the GNU General Public License (GPL) / GNU Lesser General Public License (LGPL) software. You have the right to acquire, modify and distribute the source code for this GPL/LGPL software. You can obtain the GPL/LGPL source code used in this product by downloading it from the following website

URL: < <http://www.rolanddg.com/gpl/> >



100001405

R1-060529