

CUBE MONITOR

CM-30

Owner's Manual

Thank you, and congratulations on your choice of the Roland CUBE Monitor CM-30.

Before using this unit, carefully read the sections entitled:

- IMPORTANT SAFETY INSTRUCTIONS (p. 2)
- USING THE UNIT SAFELY (p. 3 and 4)
- IMPORTANT NOTES (p. 5)

These sections provide important information concerning the proper operation of the unit. Additionally, in order to feel assured that you have gained a good grasp of every feature provided by your new unit, Owner's manual should be read in its entirety. The manual should be saved and kept on hand as a convenient reference.



This unit is equipped with a protection circuit. The protection circuit helps ensure safety by operating when excessive input continues for a long time while the device is at a location with a high ambient temperature. Sound drop-out may occur when the protection circuit is actuated during use. Please read through the documentation carefully to ensure correct use.

Main Features

- Musical instrument monitor amp with 30 W output power, yet lightweight and compact for easy portability.
- The newly developed, magnetically shielded 16 cm (6.5") coaxial two-way speaker uses highly rigid, titanium vapor-deposited polypropylene injection cones, delivering clear, distortion-free sound.
- In addition to a mic/line channel that provides an XLR-type connector, there are two stereo channels and two stereo AUX IN channels with RCA phono and stereo mini-jack connections, giving you a total of five sets of inputs. These inputs can be combined within the CM-30 by its stereo mixer.
- The Stereo Link function (p. 10) lets you easily connect two CM-30 speakers for stereo playback. When using Stereo Link, a total of ten sets of input can be used.
- The built-in, two-band equalizer lets you adjust the tone of the speaker.
- The stereo headphone jack provides a volume control that is independent of the speaker output volume.
- The cabinet is designed for easy portability. A metal grille cover protects the speaker, and the cabinet features corner protectors. There's also an easy-gripping handle for convenient carrying.

Copyright © 2004
 ROLAND CORPORATION
 All rights reserved.
 No part of this publication
 may be reproduced in any
 form without the written
 permission of ROLAND
 CORPORATION.

WARNING: To reduce the risk of fire or electric shock, do not expose this apparatus to rain or moisture.

   ATTENTION: RISQUE DE CHOC ELECTRIQUE NE PAS OUVRIR
CAUTION: TO REDUCE THE RISK OF ELECTRIC SHOCK, DO NOT REMOVE COVER (OR BACK). NO USER-SERVICEABLE PARTS INSIDE. REFER SERVICING TO QUALIFIED SERVICE PERSONNEL.



The lightning flash with arrowhead symbol, within an equilateral triangle, is intended to alert the user to the presence of uninsulated "dangerous voltage" within the product's enclosure that may be of sufficient magnitude to constitute a risk of electric shock to persons.



The exclamation point within an equilateral triangle is intended to alert the user to the presence of important operating and maintenance (servicing) instructions in the literature accompanying the product.

INSTRUCTIONS PERTAINING TO A RISK OF FIRE, ELECTRIC SHOCK, OR INJURY TO PERSONS.

IMPORTANT SAFETY INSTRUCTIONS SAVE THESE INSTRUCTIONS

WARNING - When using electric products, basic precautions should always be followed, including the following:

1. Read these instructions.
2. Keep these instructions.
3. Heed all warnings.
4. Follow all instructions.
5. Do not use this apparatus near water.
6. Clean only with a dry cloth.
7. Do not block any of the ventilation openings. Install in accordance with the manufacturers instructions.
8. Do not install near any heat sources such as radiators, heat registers, stoves, or other apparatus (including amplifiers) that produce heat.
9. Do not defeat the safety purpose of the polarized or grounding-type plug. A polarized plug has two blades with one wider than the other. A grounding type plug has two blades and a third grounding prong. The wide blade or the third prong are provided for your safety. If the provided plug does not fit into your outlet, consult an electrician for replacement of the obsolete outlet.
10. Protect the power cord from being walked on or pinched particularly at plugs, convenience receptacles, and the point where they exit from the apparatus.
11. Only use attachments/accessories specified by the manufacturer.
13. Unplug this apparatus during lightning storms or when unused for long periods of time.
14. Refer all servicing to qualified service personnel. Servicing is required when the apparatus has been damaged in any way, such as power-supply cord or plug is damaged, liquid has been spilled or objects have fallen into the apparatus, the apparatus has been exposed to rain or moisture, does not operate normally, or has been dropped.

For the U.K.

IMPORTANT: THE WIRES IN THIS MAINS LEAD ARE COLOURED IN ACCORDANCE WITH THE FOLLOWING CODE.

BLUE: NEUTRAL
BROWN: LIVE

As the colours of the wires in the mains lead of this apparatus may not correspond with the coloured markings identifying the terminals in your plug, proceed as follows:

The wire which is coloured BLUE must be connected to the terminal which is marked with the letter N or coloured BLACK.

The wire which is coloured BROWN must be connected to the terminal which is marked with the letter L or coloured RED.

Under no circumstances must either of the above wires be connected to the earth terminal of a three pin plug.



USING THE UNIT SAFELY

INSTRUCTIONS FOR THE PREVENTION OF FIRE, ELECTRIC SHOCK, OR INJURY TO PERSONS

About ⚠ WARNING and ⚠ CAUTION Notices







⚠ WARNING	Used for instructions intended to alert the user to the risk of death or severe injury should the unit be used improperly.
⚠ CAUTION	Used for instructions intended to alert the user to the risk of injury or material damage should the unit be used improperly. * Material damage refers to damage or other adverse effects caused with respect to the home and all its furnishings, as well to domestic animals or pets.

About the Symbols





	The ⚠ symbol alerts the user to important instructions or warnings. The specific meaning of the symbol is determined by the design contained within the triangle. In the case of the symbol at left, it is used for general cautions, warnings, or alerts to danger.
	The ⚡ symbol alerts the user to items that must never be carried out (are forbidden). The specific thing that must not be done is indicated by the design contained within the circle. In the case of the symbol at left, it means that the unit must never be disassembled.
	The ● symbol alerts the user to things that must be carried out. The specific thing that must be done is indicated by the design contained within the circle. In the case of the symbol at left, it means that the power-cord plug must be unplugged from the outlet.

ALWAYS OBSERVE THE FOLLOWING







WARNING

- Before using this unit, make sure to read the instructions below, and the Owner's Manual. 
- Do not open or perform any internal modifications on the unit. 
- Do not attempt to repair the unit, or replace parts within it (except when this manual provides specific instructions directing you to do so). Refer all servicing to your retailer, the nearest Roland Service Center, or an authorized Roland distributor, as listed on the "Information" page. 
- Never use or store the unit in places that are:
 - Subject to temperature extremes (e.g., direct sunlight in an enclosed vehicle, near a heating duct, on top of heat-generating equipment); or are 
 - Damp (e.g., baths, washrooms, on wet floors); or are 
 - Humid; or are
 - Exposed to rain; or are
 - Dusty; or are
 - Subject to high levels of vibration.
- The unit should be connected to a power supply only of the type described in the operating instructions, or as marked on the rear side of unit. 









WARNING

- Use only the attached power-supply cord. Also, the supplied power cord must not be used with any other device. 
- Do not excessively twist or bend the power cord, nor place heavy objects on it. Doing so can damage the cord, producing severed elements and short circuits. Damaged cords are fire and shock hazards! 
- This unit, either alone or in combination with an amplifier and headphones or speakers, may be capable of producing sound levels that could cause permanent hearing loss. Do not operate for a long period of time at a high volume level, or at a level that is uncomfortable. If you experience any hearing loss or ringing in the ears, you should immediately stop using the unit, and consult an audiologist. 
- Do not allow any objects (e.g., flammable material, coins, pins); or liquids of any kind (water, soft drinks, etc.) to penetrate the unit. 

WARNING

- Immediately turn the power off, remove the power cord from the outlet, and request servicing by your retailer, the nearest Roland Service Center, or an authorized Roland distributor, as listed on the “Information” page when:
 - The power-supply cord, or the plug has been damaged; or
 - If smoke or unusual odor occurs
 - Objects have fallen into, or liquid has been spilled onto the unit; or
 - The unit has been exposed to rain (or otherwise has become wet); or
 - The unit does not appear to operate normally or exhibits a marked change in performance.
- In households with small children, an adult should provide supervision until the child is capable of following all the rules essential for the safe operation of the unit.
- Protect the unit from strong impact. (Do not drop it!)
- Do not force the unit’s power-supply cord to share an outlet with an unreasonable number of other devices. Be especially careful when using extension cords—the total power used by all devices you have connected to the extension cord’s outlet must never exceed the power rating (watts/ amperes) for the extension cord. Excessive loads can cause the insulation on the cord to heat up and eventually melt through.
- Before using the unit in a foreign country, consult with your retailer, the nearest Roland Service Center, or an authorized Roland distributor, as listed on the “Information” page.
- Do not put anything that contains water (e.g., flower vases) on this unit. Also, avoid the use of insecticides, perfumes, alcohol, nail polish, spray cans, etc., near the unit. Swiftly wipe away any liquid that spills on the unit using a dry, soft cloth.

CAUTION

- The unit should be located so that its location or position does not interfere with its proper ventilation.
- Always grasp only the plug on the power-supply cord when plugging into, or unplugging from, an outlet or this unit.
- At regular intervals, you should unplug the power plug and clean it by using a dry cloth to wipe all dust and other accumulations away from its prongs. Also, disconnect the power plug from the power outlet whenever the unit is to remain unused for an extended period of time. Any accumulation of dust between the power plug and the power outlet can result in poor insulation and lead to fire.
- Try to prevent cords and cables from becoming entangled. Also, all cords and cables should be placed so they are out of the reach of children.
- Never climb on top of, nor place heavy objects on the unit.
- Never handle the power cord or its plugs with wet hands when plugging into, or unplugging from, an outlet or this unit.
- Before cleaning the unit, turn off the power and unplug the power cord from the outlet (p. 9).
- Whenever you suspect the possibility of lightning in your area, pull the plug on the power cord out of the outlet.
- The rear of this unit may become hot, so take care to avoid burns.

IMPORTANT NOTES

In addition to the items listed under “IMPORTANT SAFETY INSTRUCTIONS” and “USING THE UNIT SAFELY” on pages 2, 3 and 4, please read and observe the following:

Power Supply

- Do not connect this unit to same electrical outlet that is being used by an electrical appliance that is controlled by an inverter (such as a refrigerator, washing machine, microwave oven, or air conditioner), or that contains a motor. Depending on the way in which the electrical appliance is used, power supply noise may cause this unit to malfunction or may produce audible noise. If it is not practical to use a separate electrical outlet, connect a power supply noise filter between this unit and the electrical outlet.
- Before connecting this unit to other devices, turn off the power to all units. This will help prevent malfunctions and/or damage to speakers or other devices.
- Although the LED are switched off when the POWER switch is switched off, this does not mean that the unit has been completely disconnected from the source of power. If you need to turn off the power completely, first turn off the POWER switch, then unplug the power cord from the power outlet. For this reason, the outlet into which you choose to connect the power cord’s plug should be one that is within easy reach.

Placement

- This device may interfere with radio and television reception. Do not use this device in the vicinity of such receivers.
- Noise may be produced if wireless communications devices, such as cell phones, are operated in the vicinity of this unit. Such noise could occur when receiving or initiating a call, or while conversing. Should you experience such problems, you should relocate such wireless devices so they are at a greater distance from this unit, or switch them off.
- Do not expose the unit to direct sunlight, place it near devices that radiate heat, leave it inside an enclosed vehicle, or otherwise subject it to temperature extremes. Also, do not allow lighting devices that normally are used while their light source is very close to the unit (such as a piano light), or powerful spotlights to shine upon the same area of the unit for extended periods of time. Excessive heat can deform or discolor the unit.
- When moved from one location to another where the temperature and/or humidity is very different, water droplets (condensation) may form inside the unit. Damage or malfunction may result if you attempt to use the unit in this condition. Therefore, before using the unit, you must allow it to stand for several hours, until the condensation has completely evaporated.

- Do not allow rubber, vinyl, or similar materials to remain on the unit for long periods of time. Such objects can discolor or otherwise harmfully affect the finish.
- Do not paste stickers, decals, or the like to this instrument. Peeling such matter off the instrument may damage the exterior finish.

Maintenance

- For everyday cleaning wipe the unit with a soft, dry cloth or one that has been slightly dampened with water. To remove stubborn dirt, use a cloth impregnated with a mild, non-abrasive detergent. Afterwards, be sure to wipe the unit thoroughly with a soft, dry cloth.
- Never use benzene, thinners, alcohol or solvents of any kind, to avoid the possibility of discoloration and/or deformation.

Additional Precautions

- Use a reasonable amount of care when using the unit’s buttons, sliders, or other controls; and when using its jacks and connectors. Rough handling can lead to malfunctions.
- When connecting / disconnecting all cables, grasp the connector itself—never pull on the cable. This way you will avoid causing shorts, or damage to the cable’s internal elements.
- A small amount of heat will radiate from the unit during normal operation.
- To avoid disturbing your neighbors, try to keep the unit’s volume at reasonable levels. You may prefer to use headphones, so you do not need to be concerned about those around you (especially when it is late at night).
- When you need to transport the unit, package it in the box (including padding) that it came in, if possible. Otherwise, you will need to use equivalent packaging materials.
- Use a cable from Roland to make the connection. If using some other make of connection cable, please note the following precautions.
 - Some connection cables contain resistors. Do not use cables that incorporate resistors for connecting to this unit. The use of such cables can cause the sound level to be extremely low, or impossible to hear. For information on cable specifications, contact the manufacturer of the cable.

Panel Descriptions

■ Control Panel

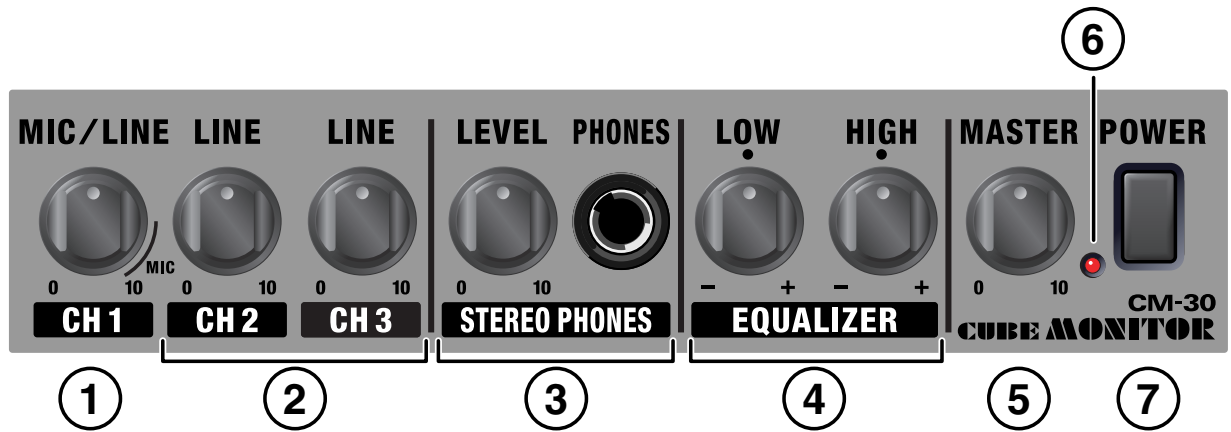

■ Jack Panel

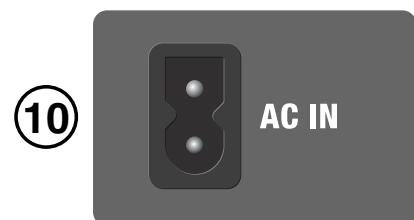
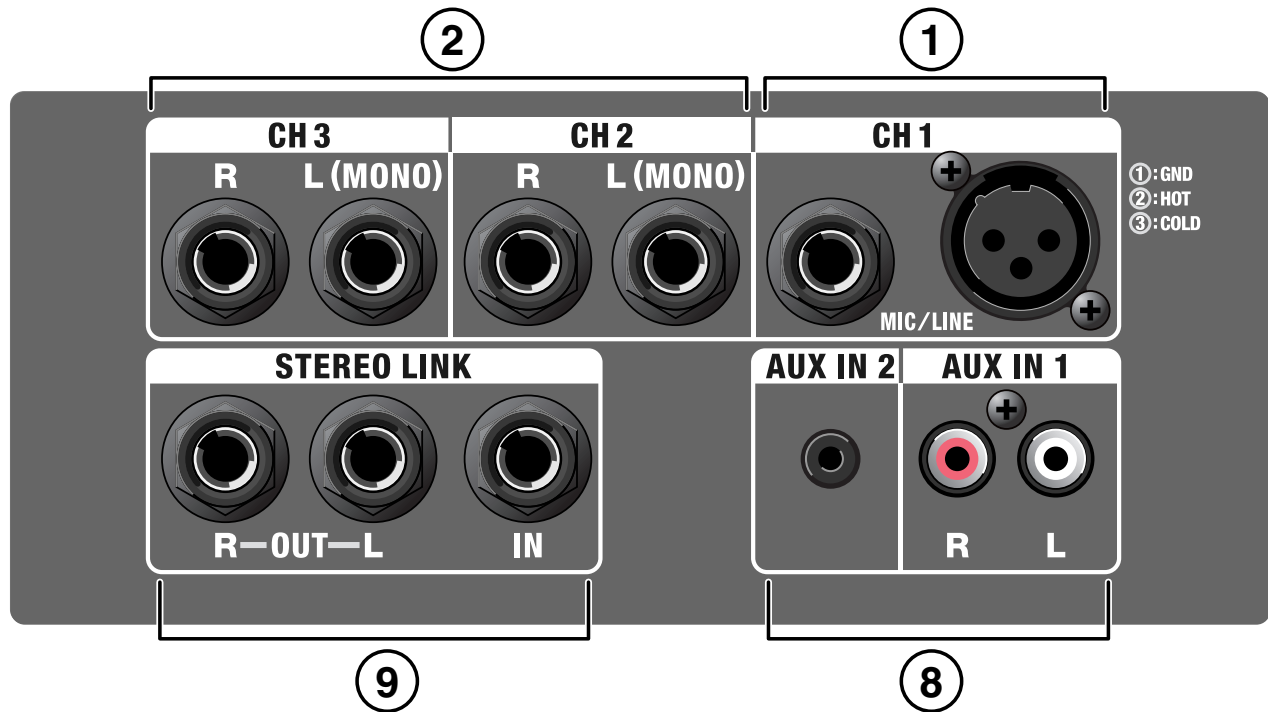

1. CH 1 knob / CH 1 Input Jacks

In addition to a 1/4" phone jack, this channel is equipped with a balanced XLR connector, useful for connecting microphones.

This accepts input levels ranging from mic input (-50 dBu) to line level from sound modules and other equipment (-20 dBu).

* *The pin assignment for the XLR type connectors is as shown below. Before making any connections, make sure that this pin assignment is compatible with that of all your other devices.*

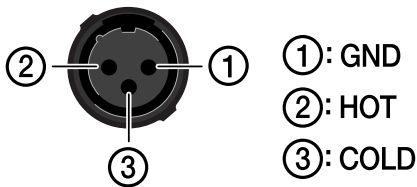

2. CH 2 and CH 3 knobs / CH 2 and CH 3 Input Jacks

Use these for connecting keyboards, sound modules, and other devices.

You can make stereo connections to these inputs. If you connect only the L jack, the input will be mono.

If you're using stereo connections, you can listen in stereo through headphones or when using a pair of stereo-linked CM-30 speakers.

They accept line level input (-20 dBu).

3. STEREO PHONES

The headphones allow you to listen in stereo.

LEVEL Knob

This knob adjusts the headphones volume.

PHONES Jack

This is for connecting headphones.

* *Before plugging in or unplugging headphones, be sure to place the LEVEL knob at 0.*

4. EQUALIZER

LOW Knob

This adjusts the level of the bass range.

HIGH Knob

This adjusts the level of the treble range.

5. MASTER Knob

This adjusts the total volume level of the unit's internal speaker.

6. Power Indicator

This indicator illuminates when the power is on.

7. POWER Switch

This switches the power on and off.

* *Always be sure to lower the MASTER knob on the CM-30 to 0 whenever turning the power on or off.*

* *This unit is equipped with a protection circuit. A brief interval (a few seconds) after power up is required before the unit will operate normally. Slight pop noise may come from the speakers when the power is switched on, but this does not indicate a problem.*

* *Refer to p. 9 for the order in which to turn the power to connected devices on and off.*

8. AUX IN 1, 2 Jacks

AUX IN 1 are RCA phono type input jacks. AUX IN 2 is stereo miniature phone type input jack.

You use these to connect equipment such as CD and MD players, and have them sound along with the equipment connected to CH 1 through CH 3.

Both AUX IN 1 and 2 accept level input of -10 dBu.

* *To adjust the volume level of equipment connected to the AUX IN jacks, use the controls on such equipment.*

9. STEREO LINK

Stereo playback is enabled simply by connecting two CM-30 units with a single or double audio cables (phone type).

* *For details on the Stereo Link function, refer to "Using Two CM-30 Speakers for Stereo Playback (Stereo Link)" (p. 10).*

They provide -10 dBu line level output, and accept level input of -10 dBu.

10. AC IN Jack

Connect the included power cord to this jack.

* *Use only the power cord included with the CM-30.*

Making the Connections

Refer to the figure shown below to connect the CM-30 and the other equipment.

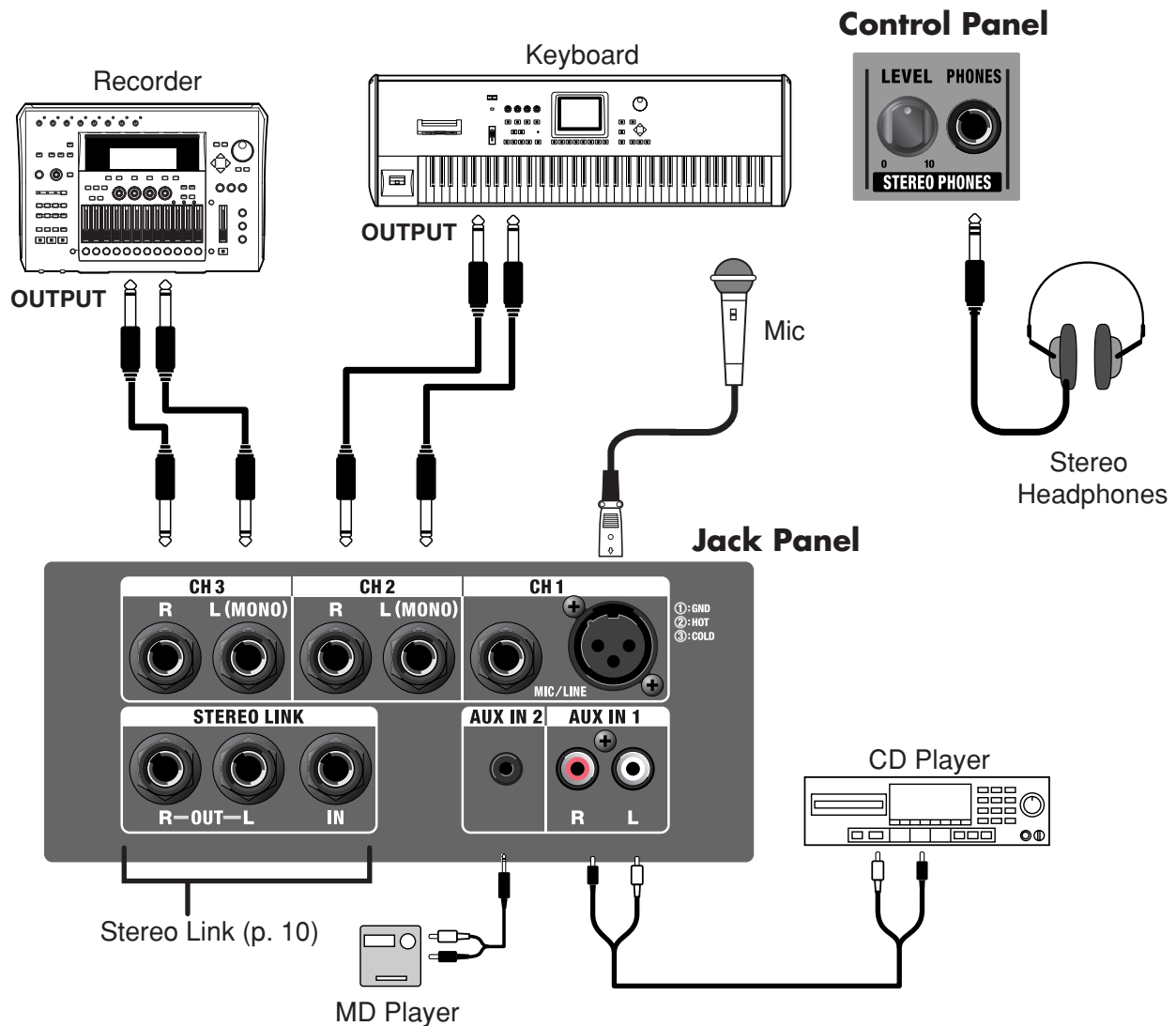

Here is an example of a setup that makes full use of the CM-30's mixer and monitor functions.

A mic is input to CH 1, which accepts mic level input. Connect a keyboard, recorder, or other sound-generating devices to the CH 2 and CH 3 inputs.

* To prevent malfunction and/or damage to speakers or other devices, always turn down the volume, and turn off the power on all devices before making any connections. Set all of the CM-30's channel volume knobs as well as the MASTER knob to zero.

* Howling could be produced depending on the location of microphones relative to speakers. This can be remedied by:

1. Changing the orientation of the microphone.
2. Relocating microphone at a greater distance from speakers.
3. Lowering volume levels.

* When connection cables with resistors are used, the volume level of equipment connected to the inputs (CH 1 through CH 3, AUX IN 1 and 2) may be low. If this happens, use connection cables that do not contain resistors, such as those from the Roland PCS series.

Switching the Power On and Off

Once the connections have been completed, turn on power to your various devices in the order specified. By turning on devices in the wrong order, you risk causing malfunction and/or damage to speakers and other devices.

1. Make sure that all volume controls on the CM-30 and connected devices are set to 0.
2. Turn on all the devices connected to the CM-30's input jacks (CH 1 through CH 3, AUX IN 1 and 2).
3. Turn on the CM-30.
4. Adjust the volume levels for the devices.
5. Before switching off the power, lower the volume on each of the devices in your system and then TURN OFF the devices in the reverse order to which they were switched on.

- * This unit is equipped with a protection circuit. A brief interval (a few seconds) after power up is required before the unit will operate normally. For protection from sudden big sound, always make sure to have the volume level turned down before switching on power.
- * Even with the volume all the way down, you may still hear some sound when the power is switched on, but this is normal, and does not indicate a malfunction.

About the Volume-level Settings

In order to get optimum sound from the CM-30 when performing, set the volume as described below.

1. Operate the CH 1 through CH 3 volume knobs to adjust the volume level for CH 1 through CH 3.

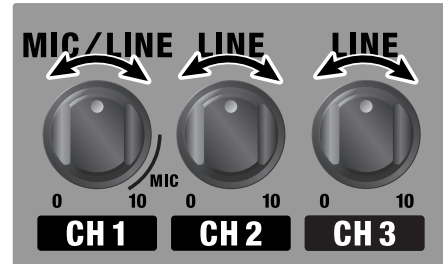

Adjust the volume balance for CH 1 through CH 3 at this time.

- * To adjust the volume levels of equipment connected to the AUX IN 1 and 2 jacks, use the controls on such equipment.
2. Adjust the LOW and HIGH knobs to obtain the tone you want.
 3. Use the MASTER knob to adjust the overall volume level.



- * If the sound is distorted, lower the CH 1 through CH 3 volume knobs, MASTER knob and/or the volume knobs for devices connected to the input jacks (CH 1 through CH 3, AUX IN 1 and 2).

Using Two CM-30 Speakers for Stereo Playback (Stereo Link)

Stereo playback is enabled simply by connecting two CM-30 units with a single or double audio cables (phone type). This function is called "Stereo Link."

Since the CM-30's mixer section operates in stereo, the L or R channel signal can be output from a STEREO LINK OUT jack. This means you can enjoy stereo playback by making connections as follows.

- Basic (up to five inputs) stereo playback (Connection example 1)
- Stereo playback (up to ten inputs) using the mixers of both CM-30 units (Connection example 2)

Example 1

You can connect up to five input sources.

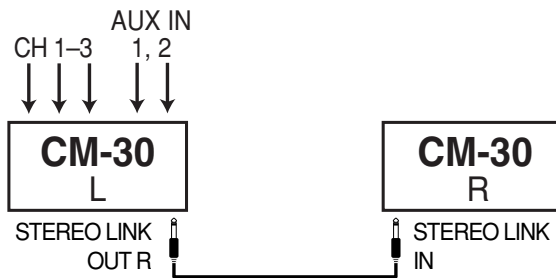

Operation

1. Connect the devices to the L CM-30.
2. Connect the STEREO LINK OUT R jack on the L CM-30 and the STEREO LINK IN jack on the R CM-30.
3. Turn on both L and R CM-30.
4. Adjust the volume levels on all devices.
5. Adjust the R and L CM-30 volume levels separately using their MASTER knobs.

If you want to connect input sources to the R CM-30

As described in step 1 of example 1, connect the R side's STEREO LINK OUT L jack to the L side's STEREO LINK IN jack.

Example 2

You can connect up to ten input sources.

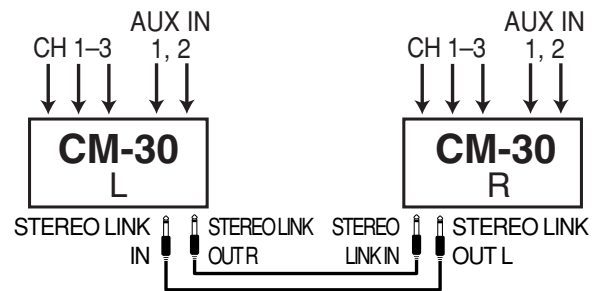

Operation

1. Connect the devices to the L and R CM-30.
2. Connect the STEREO LINK OUT R jack on the L CM-30 and the STEREO LINK IN jack on the R CM-30.
3. Connect the STEREO LINK OUT L jack on the R CM-30 and the STEREO LINK IN jack on the L CM-30.
4. Turn on both L and R CM-30.
5. Adjust the volume levels on all devices.
6. Adjust the R and L CM-30 volume levels separately using their MASTER knobs.

About the Volume and Tone Settings

Adjust the R and L volume levels separately using their MASTER knobs.

You can adjust the equalizer (LOW and HIGH knobs) independently for the L and R sides.

Basically, they should be set to the same positions, but you can adjust each one as necessary to suit the needs of a particular setup.

* The STEREO PHONES jack will provide stereo playback of only the sources connected to the local speaker (L or R).

Using a Microphone Stand

By using a mic stand, you can mount the CM-30 at the optimal height for use as a monitor speaker or simple PA device.

Requirements when using a mic stand

- As shown in the diagram below, the mic stand's tripod must be extended to its maximum width (at least 63 cm/25 inches) and the height must be less than 110 cm (including the CM-30).

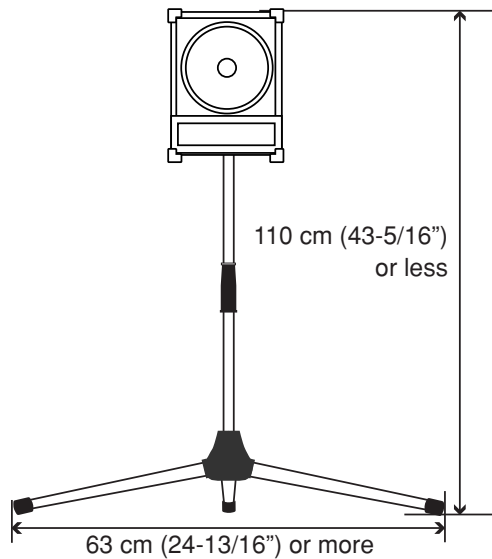

- Using a mic stand that does not meet the specifications above may result in damage to equipment or injury due to the stand tipping over.
- When using CM-30 with a mic stand, the mic stand must be carefully placed so it is level and sure to remain stable.
- Cables connected to CM-30 should be given enough slack to prevent accidents that might result from someone tripping over them.
- To prevent accidents due to falls, do not place any object on the CM-30 when it's mounted on a mic stand.

Mounting the CM-30 to a mic stand

Always have at least one other person assist you when mounting the CM-30 on a mic stand, or when adjusting the height of the stand while the CM-30 remains mounted on it.

1. As shown in the diagram, place the CM-30 upside down and rotate the mic stand to screw it firmly into the CM-30's mic stand holder.

* When turning the unit upside-down, get a bunch of newspapers or magazines, and place them under the four corners or at both ends to prevent damage to the buttons and controls. Also, you should try to orient the unit so no buttons or controls get damaged.

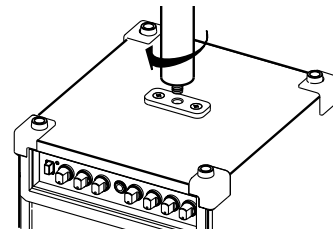

2. Open the tripod so it's at full spread. If the tripod is not fully opened, the stand will be unstable.
3. Grasp the CM-30 and mic stand, and place them upright on the floor.
4. Adjust the height of the mic stand as desired, but do not allow the height (including the CM-30) to exceed 110 cm (approx. 43 inches).
5. Firmly tighten the hardware of the mic stand so that the CM-30 does not wobble to left or right.

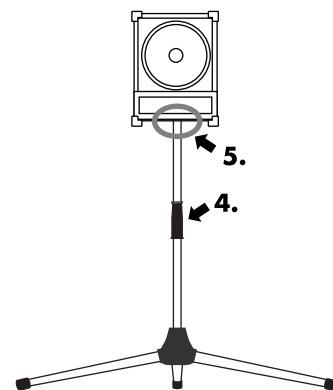

* Be careful not to pinch your fingers while performing these steps.

Appendices

Block Diagram

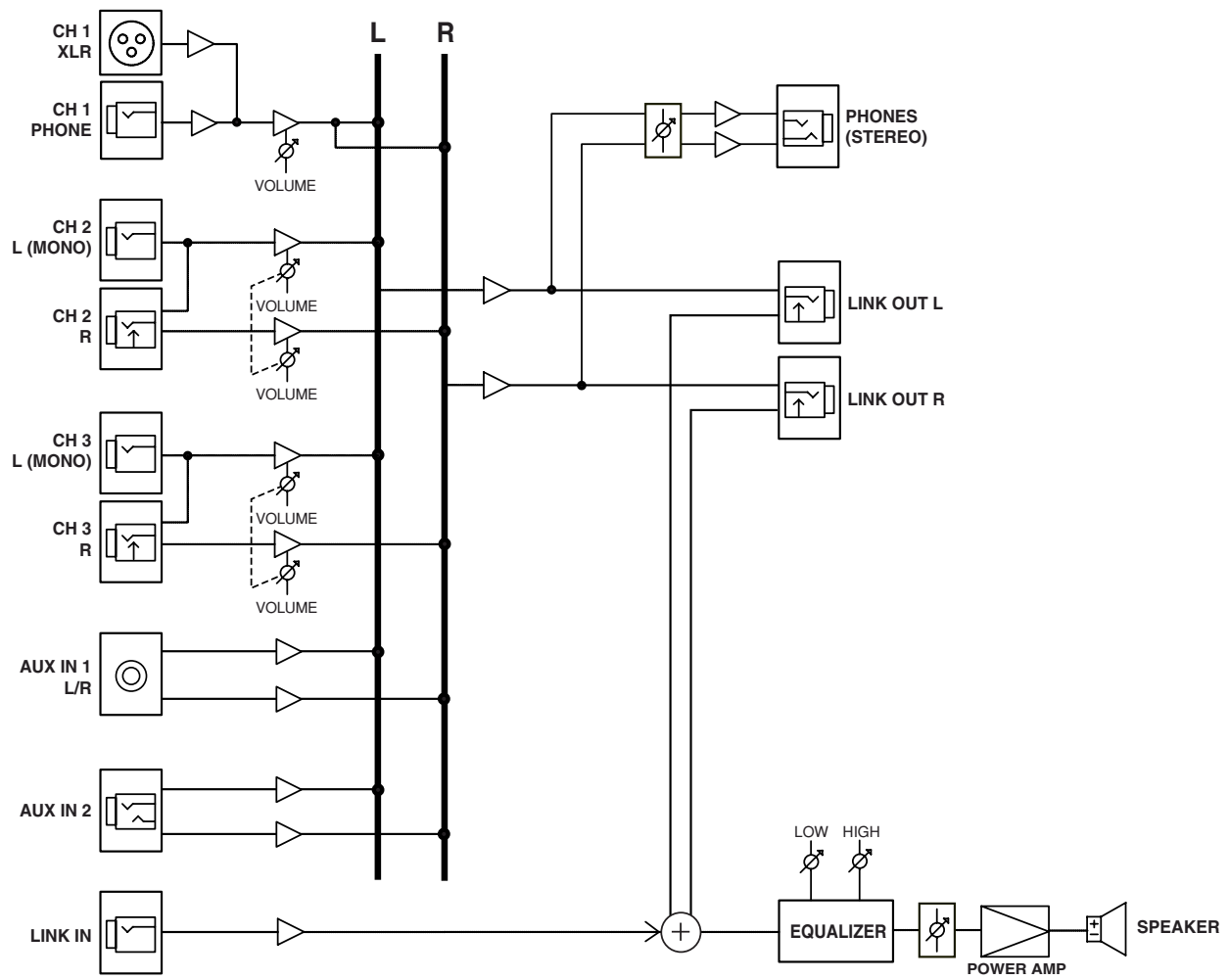

Main Specifications

● Rated Power Output

30 W

● Nominal Input Level (1 kHz)

Channel 1 (MIC/LINE): -50 – -20 dBu

Channel 2, 3 (LINE): -20 dBu

AUX IN 1, 2: -10 dBu

STEREO LINK IN: -10 dBu

● Nominal Output Level (1 kHz)

STEREO LINK OUT L/R: -10 dBu

* $0 \text{ dBu} = 0.775 \text{ V}_{\text{rms}}$

● Speakers

16 cm (6.5 inches) + Tweeter (Coaxial 2-way)

● Controls

CH 1 (MIC/LINE), Volume knob

CH 2, 3 (LINE), Volume knobs

STEREO PHONES LEVEL knob

EQUALIZER: LOW knob, HIGH knob

MASTER Knob

POWER Switch

● Indicator

POWER

● Connectors

CH 1 INPUT jacks (XLR type, 1/4" phone type)

CH 2 and 3 INPUT L (MONO) jacks

(1/4" phone type)

CH 2 and 3 INPUT R jacks (1/4" phone type)

AUX IN 1 L, R jacks (RCA phono type)

AUX IN 2 jack (Stereo miniature phone type)

STEREO LINK OUT L, R jacks (1/4" phone type)

STEREO LINK IN jack (1/4" phone type)

STEREO PHONES jack (Stereo 1/4" phone type)

● Power Supply

AC 117 V, AC 230 V, AC 240 V

● Power Consumption

32 W

● Dimensions

214 (W) x 238 (D) x 275 (H) mm

8-7/16 (W) x 9-3/8 (D) x 10-7/8 (H) inches

● Weight

5.6 kg / 12 lbs 6 oz

● Accessory

Owner's Manual, Power cord

* *In the interest of product improvement, the specifications and/or appearance of this unit are subject to change without prior notice.*

MEMO

MEMO

ROLAND MONITOR GM-30



For EU Countries

This product complies with the requirements of European Directives EMC 89/336/EEC and LVD 73/23/EEC.